

RU

GB

INSTALLATION MANUAL
SKID PLATE FOR ENGINE BAY AND TRANSMISSION CASE



TOYOTA Highlander 3,5 AT FULLWD

2021- 

24.4761/24.4762

12/01/21

1/7



(RU) /
(GB) Location/Position Arrow

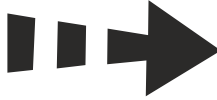

(RU)
(GB) Movement Arrow



(RU)
(GB) Screw Arrow

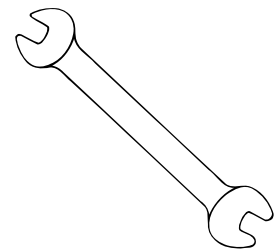
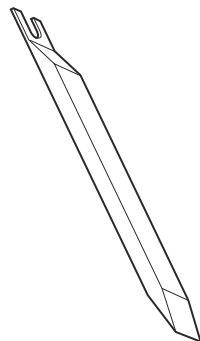
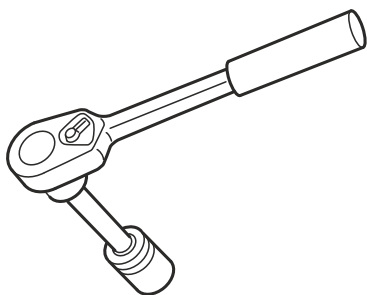
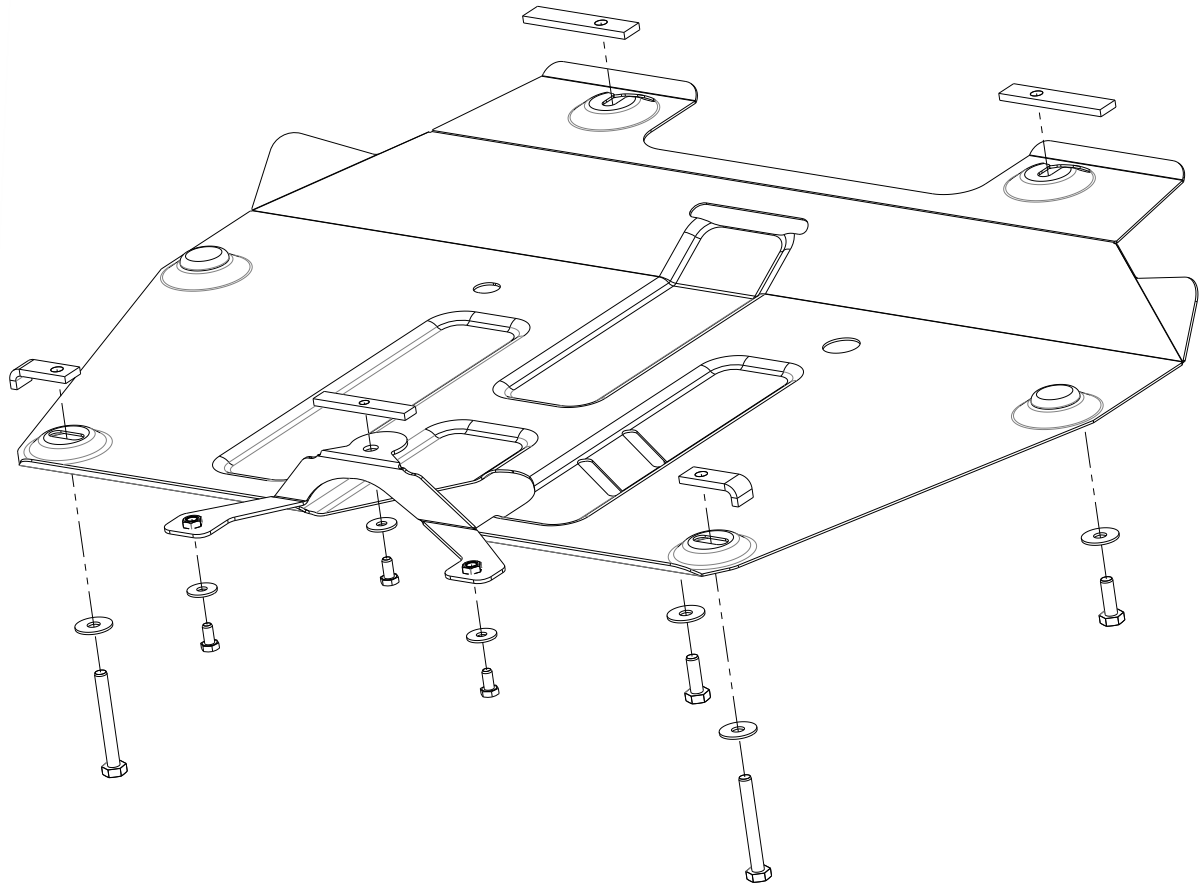

13 mm

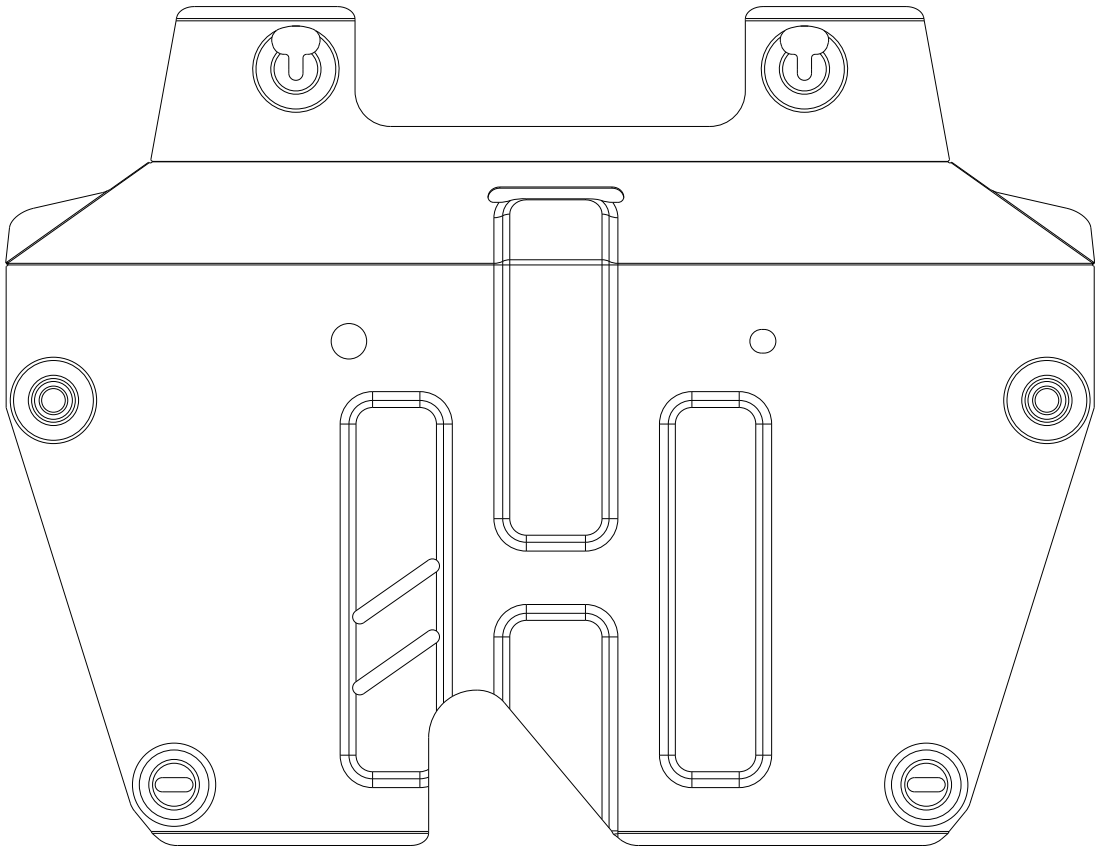
A

1X

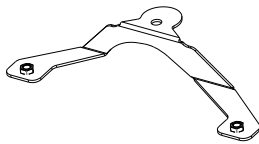
B

1X

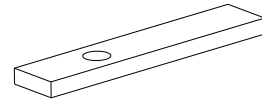

3004

2X

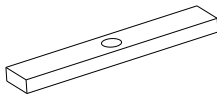
D

3006

1X

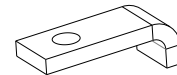
E

16002

2X

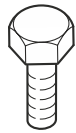
F

M8 16

3X

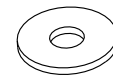
G

Ø8

3X

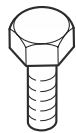
H

M10 30

2X

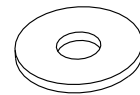
I

Ø10

4X

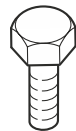
J

M10 80

2X

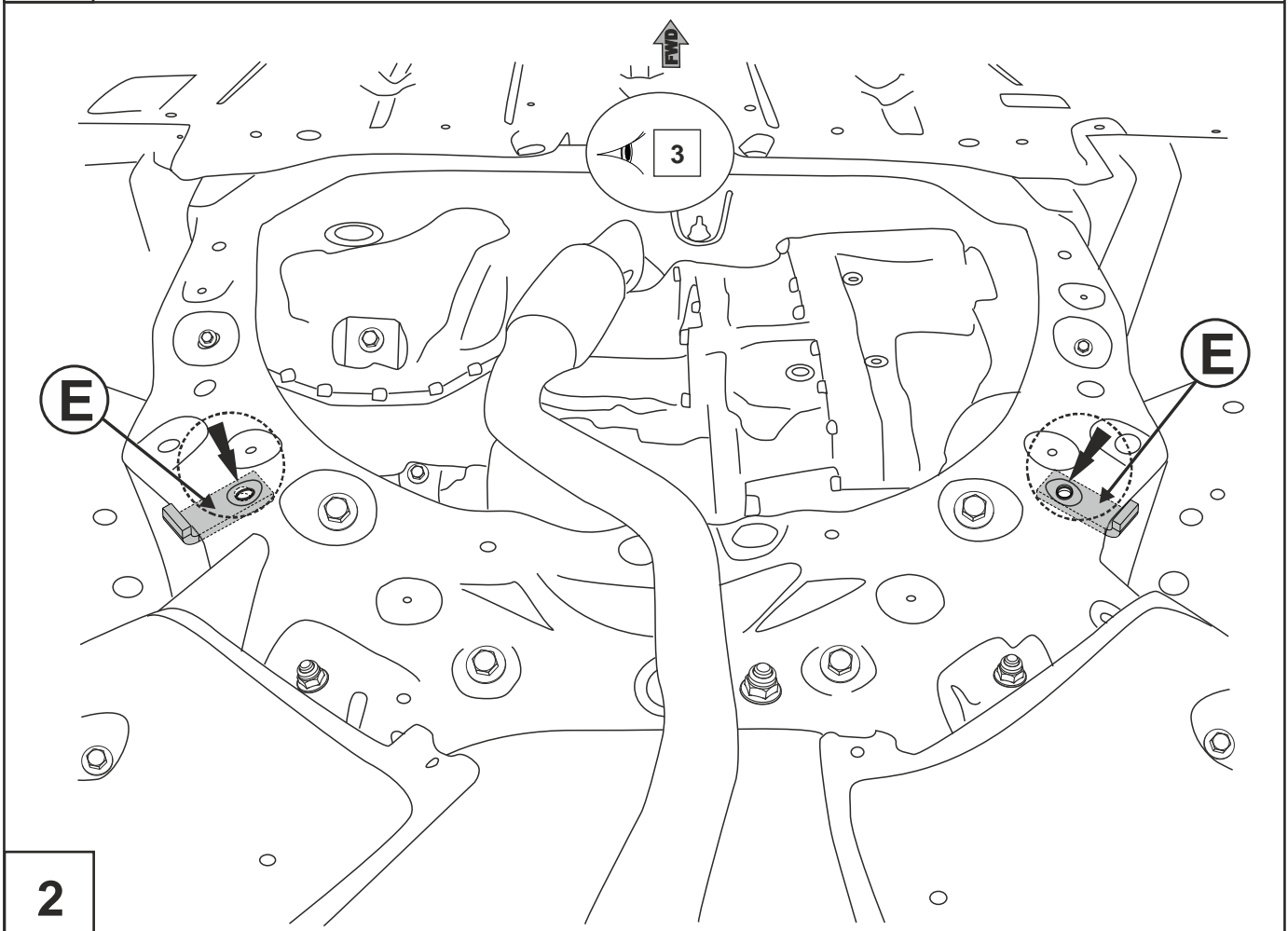
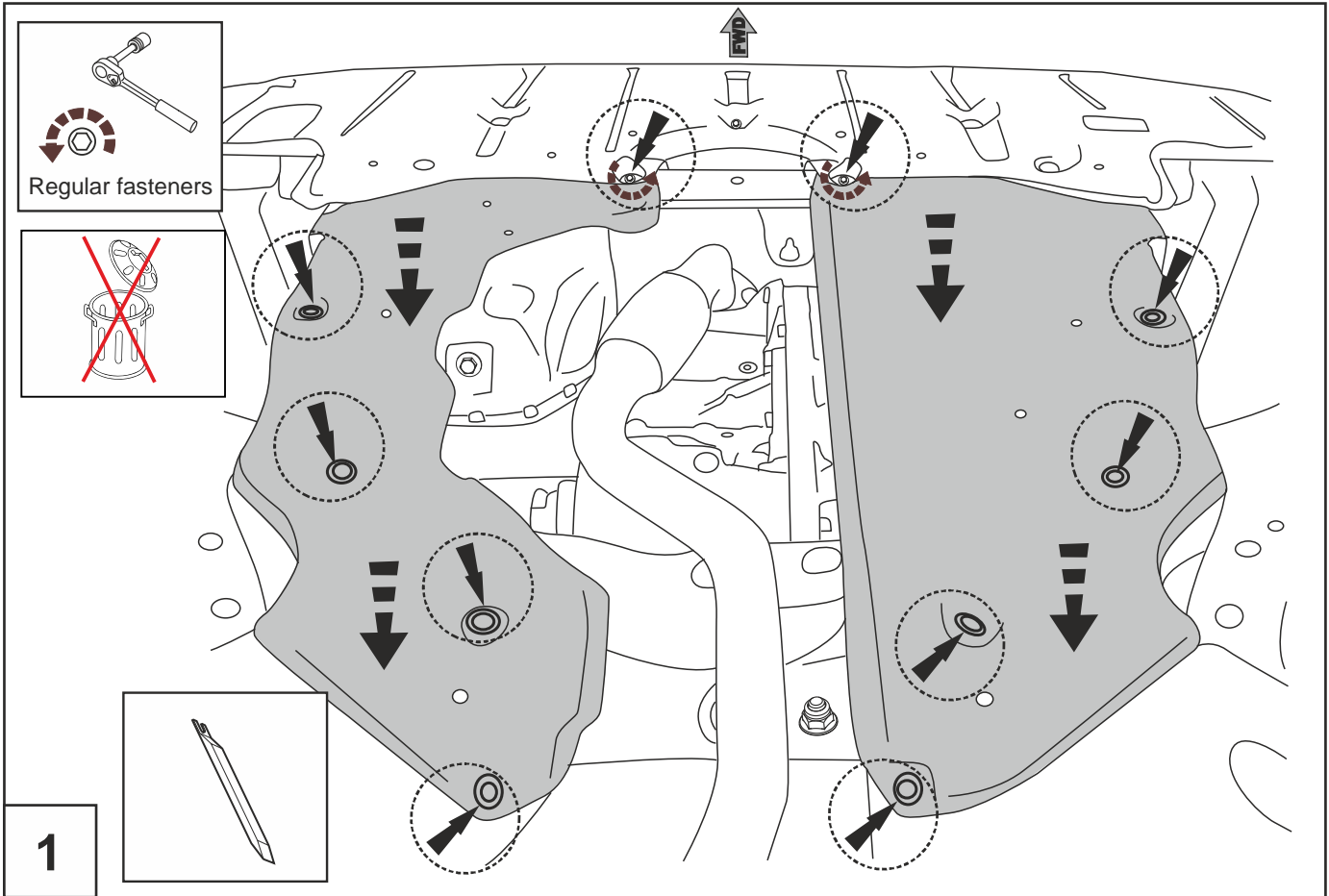

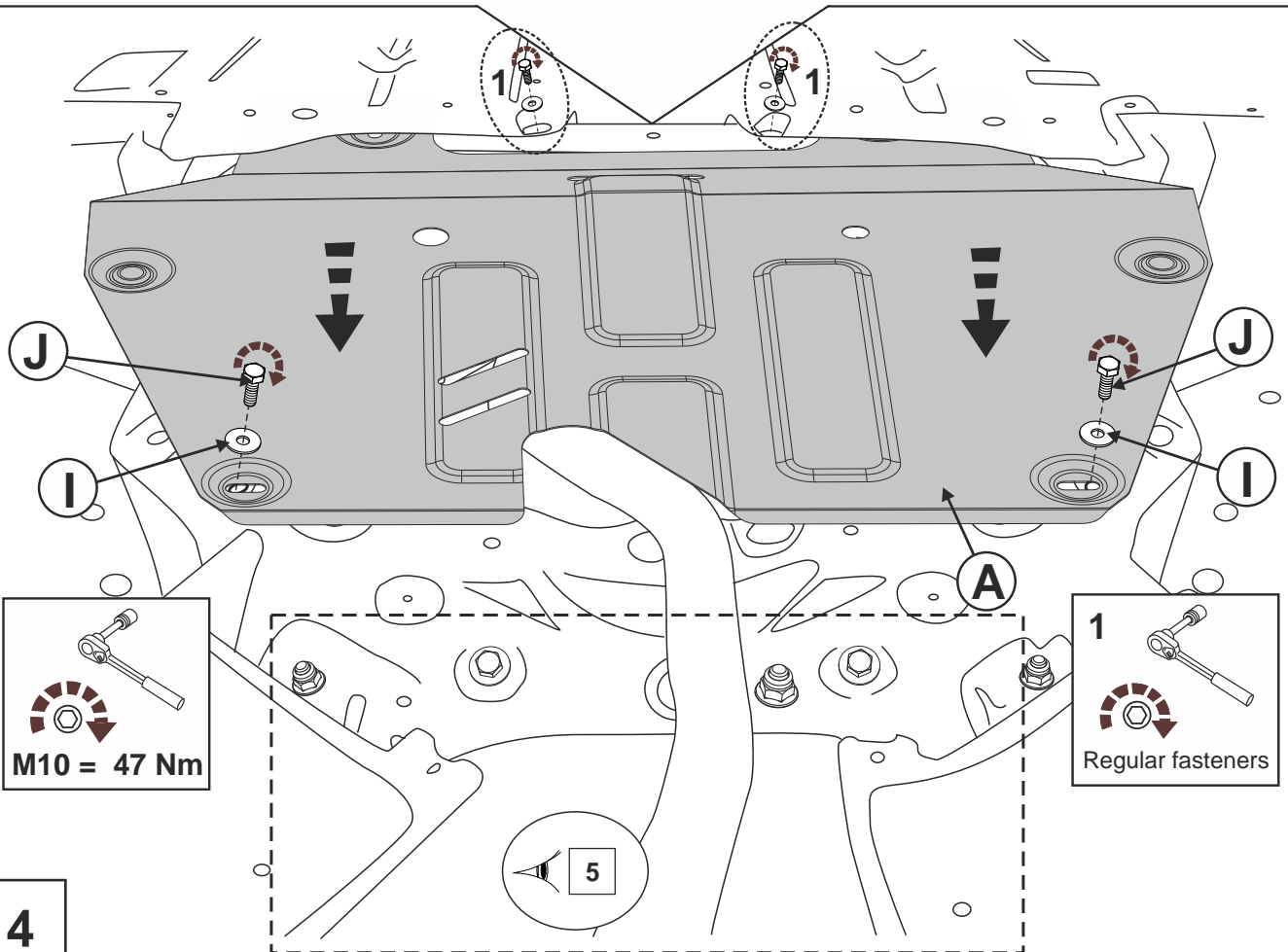
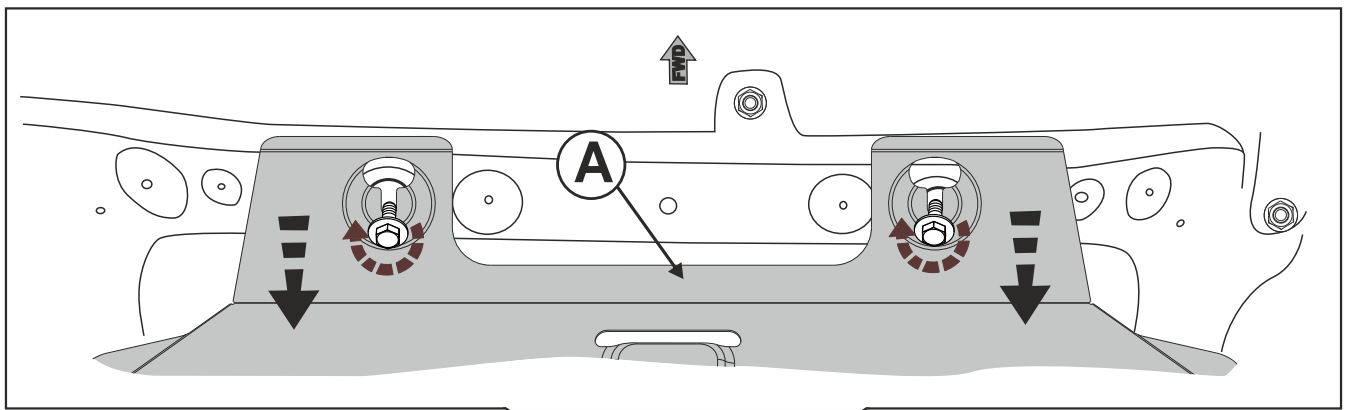
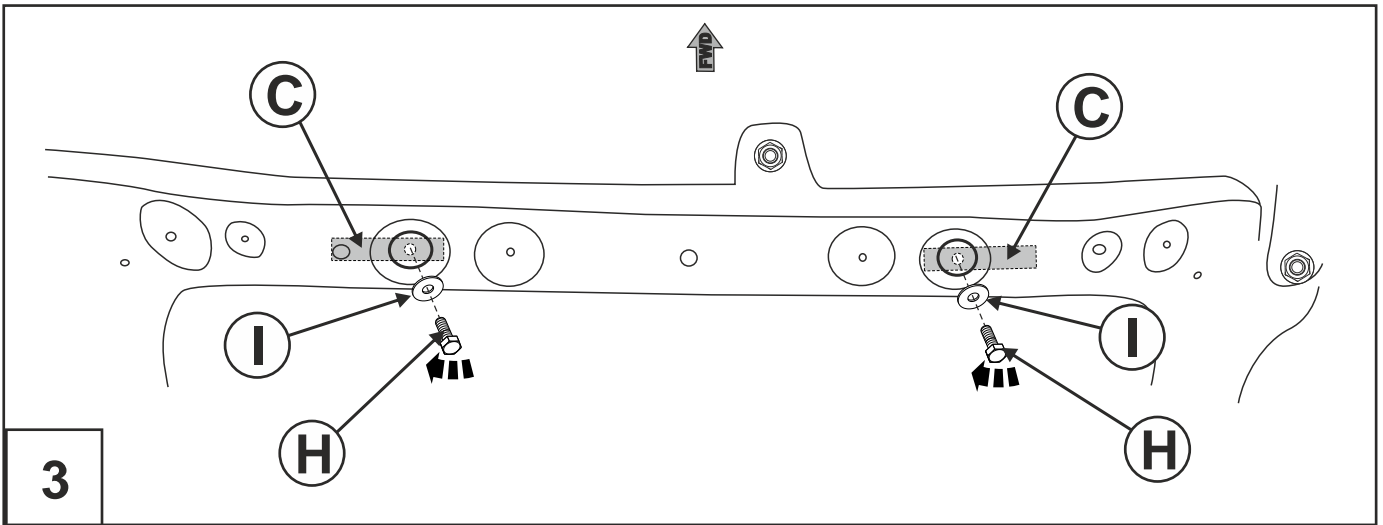

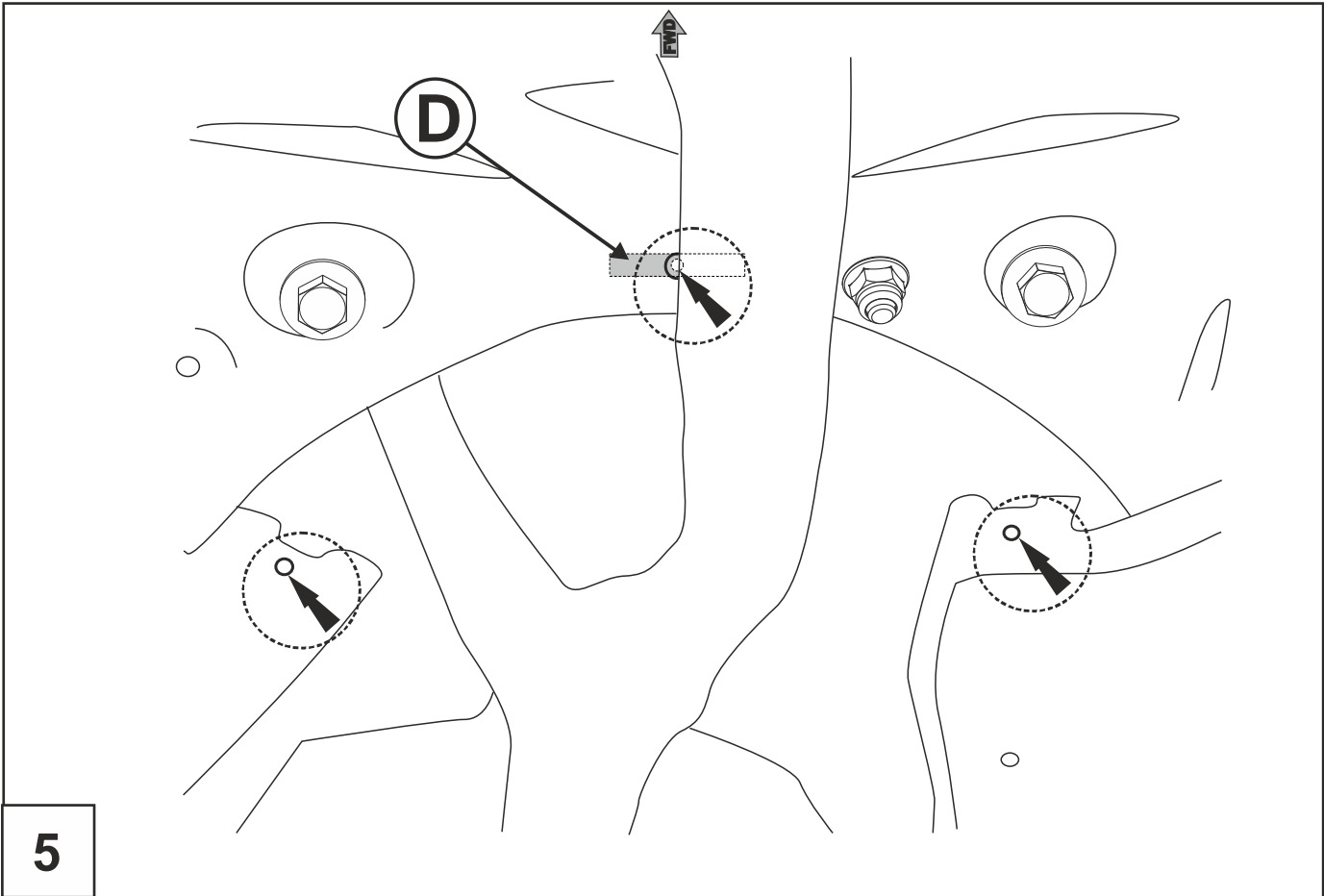

5

13 mm

M8 = 24 Nm

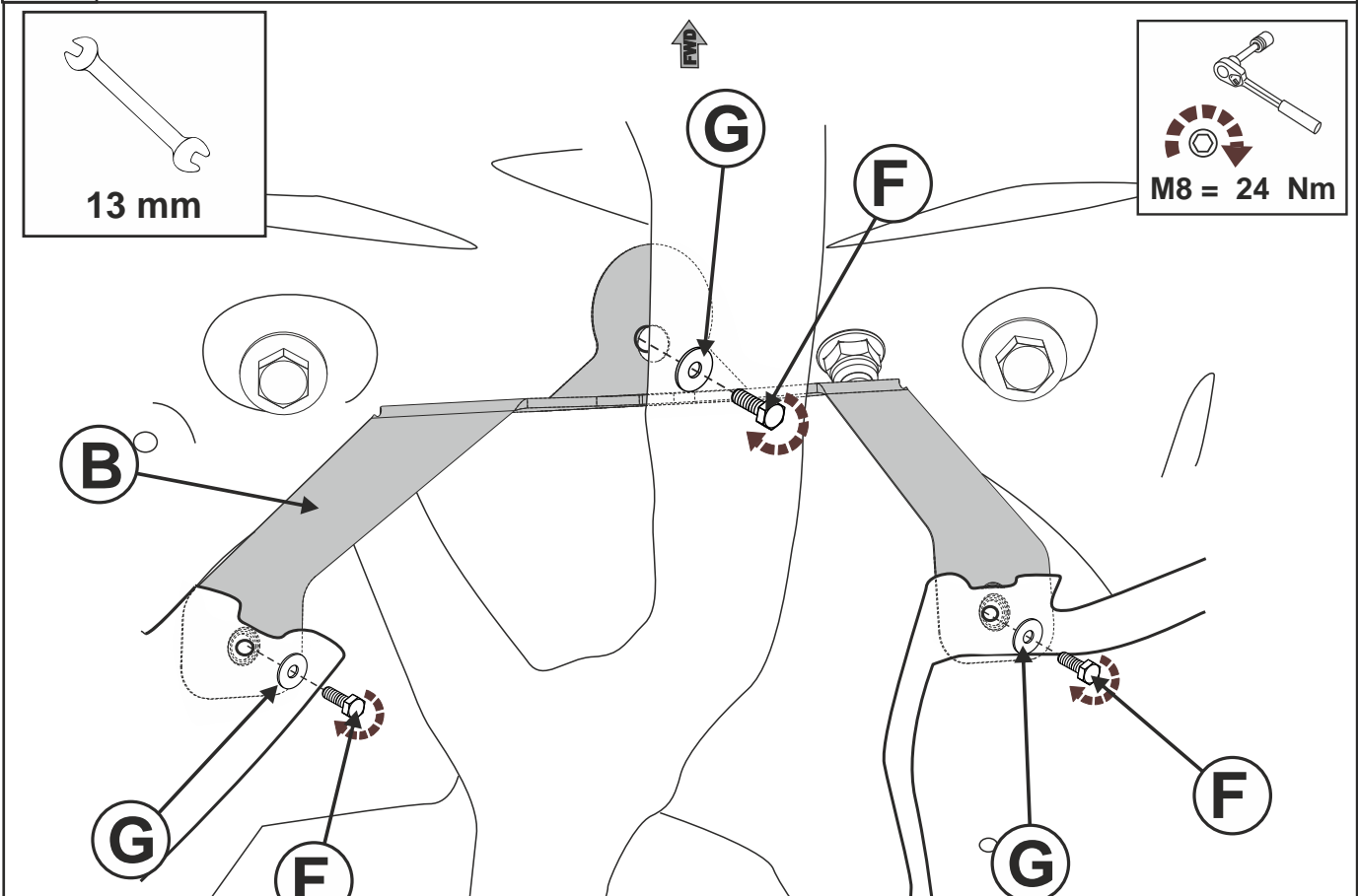

6

