

RU

7 12 16 17 15 18 9 1 7 10 14 13 18 16 17 12 13 1 9 4  
6 4 7 17 9 15 17 4 15 7 9 14 14

GB

INSTALLATION MANUAL  
SKID PLATE FOR ENGINE BAY AND TRANSMISSION CASE



HONDA Stepwgn 1,5 AT FWD

2015 - 

09.4638/09.4639

14/08/20

1/6



RU ⑭513131186525171641916  
 GB Location/Position Arrow

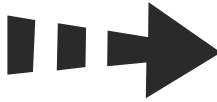

RU ③13171641916  
 GB Movement Arrow



RU ⑭513131186525171641916  
 GB Screw Arrow

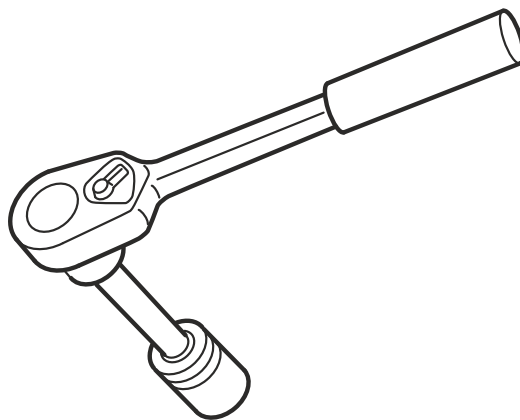
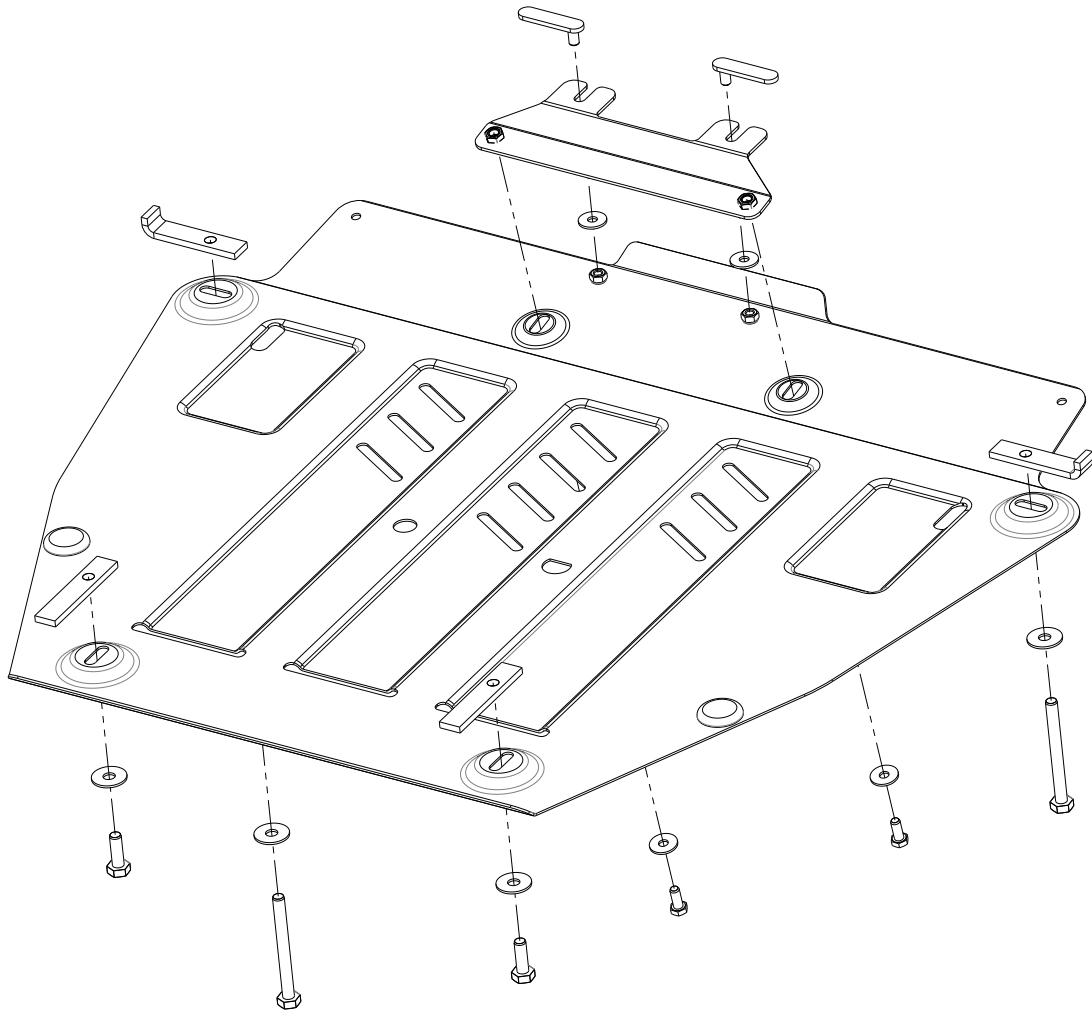

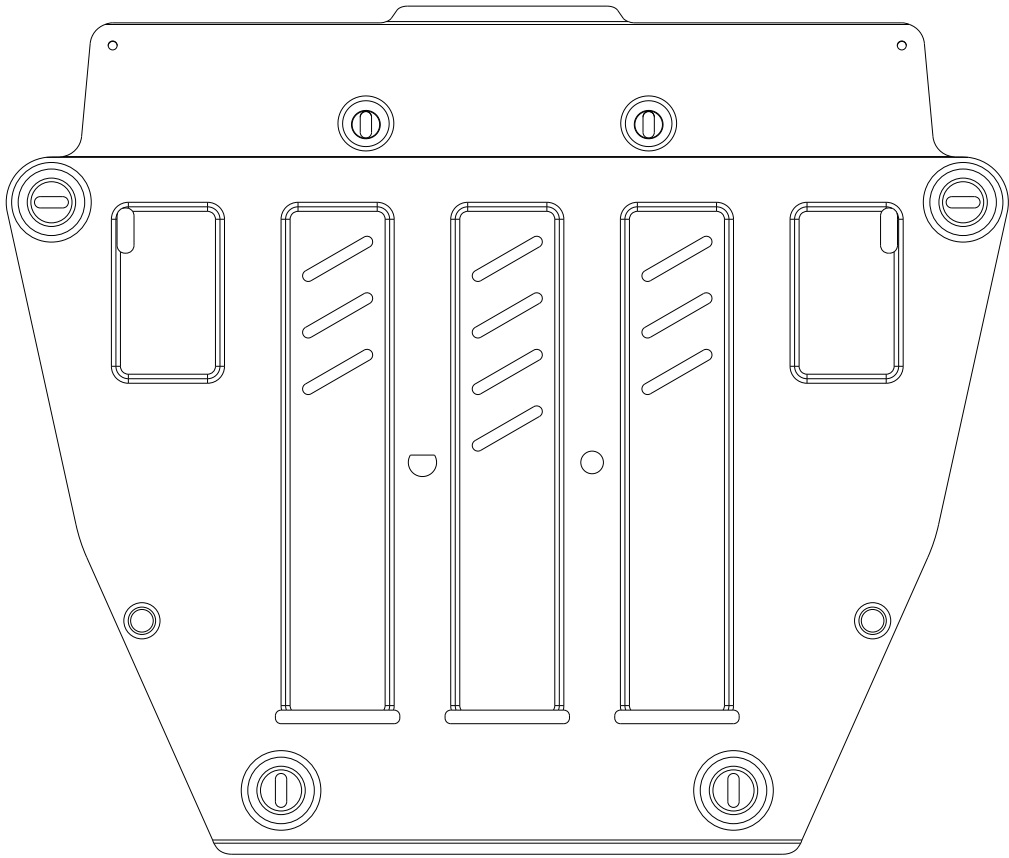
**A**

1X

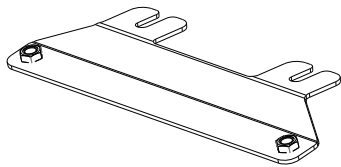
**B**

1X

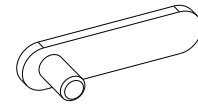
**16**

⑫③ 17003

2X

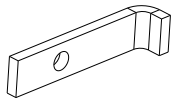
**D**

⑫③ 16001

2X

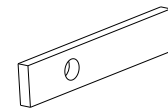
**E**

⑫③ 3004

2X

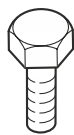
**F**

M1012100

2X

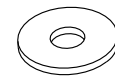
**G**

Ø 8

4X

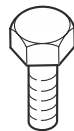
**H**

M8120

2X

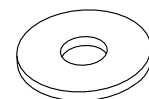
**I**

Ø 10

4X

**J**

M101230

2X

**K**

M8

2X



09.4638/09.4639

14/08/20

3/6

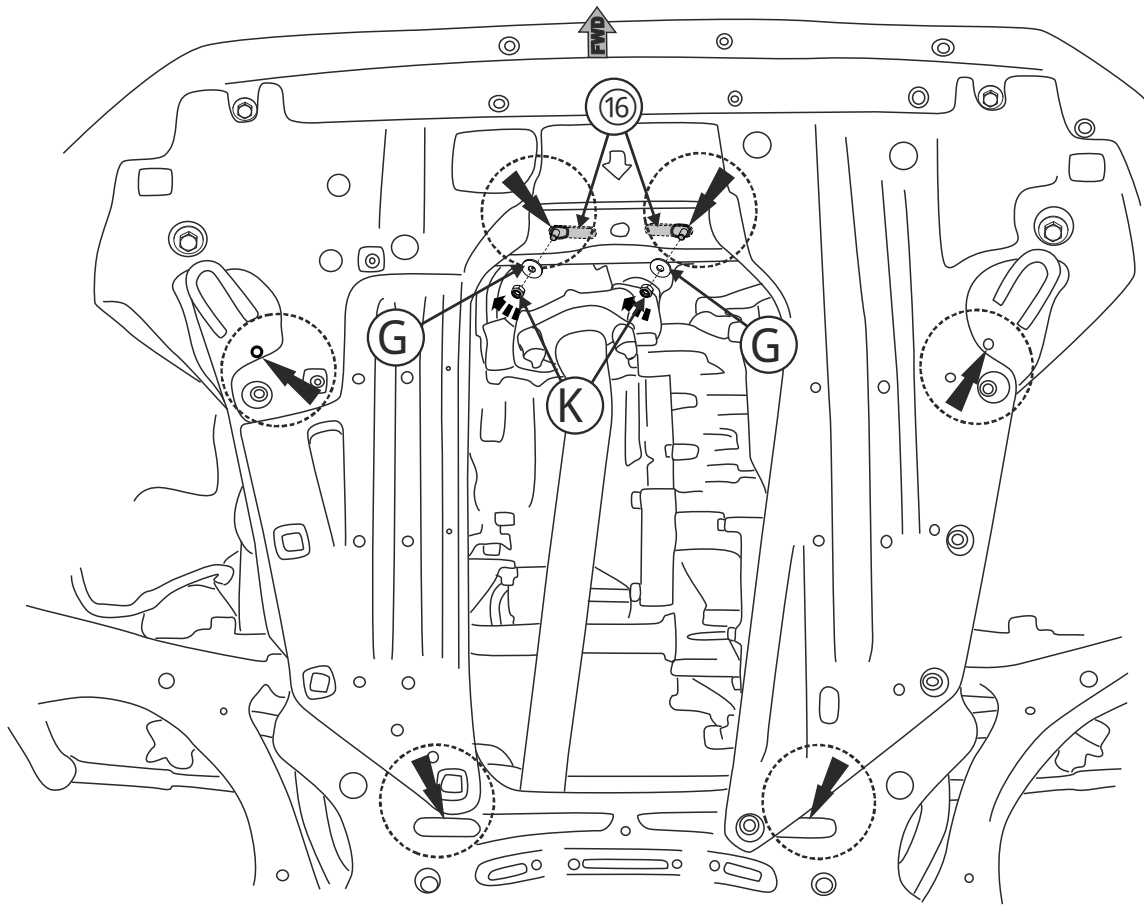

1

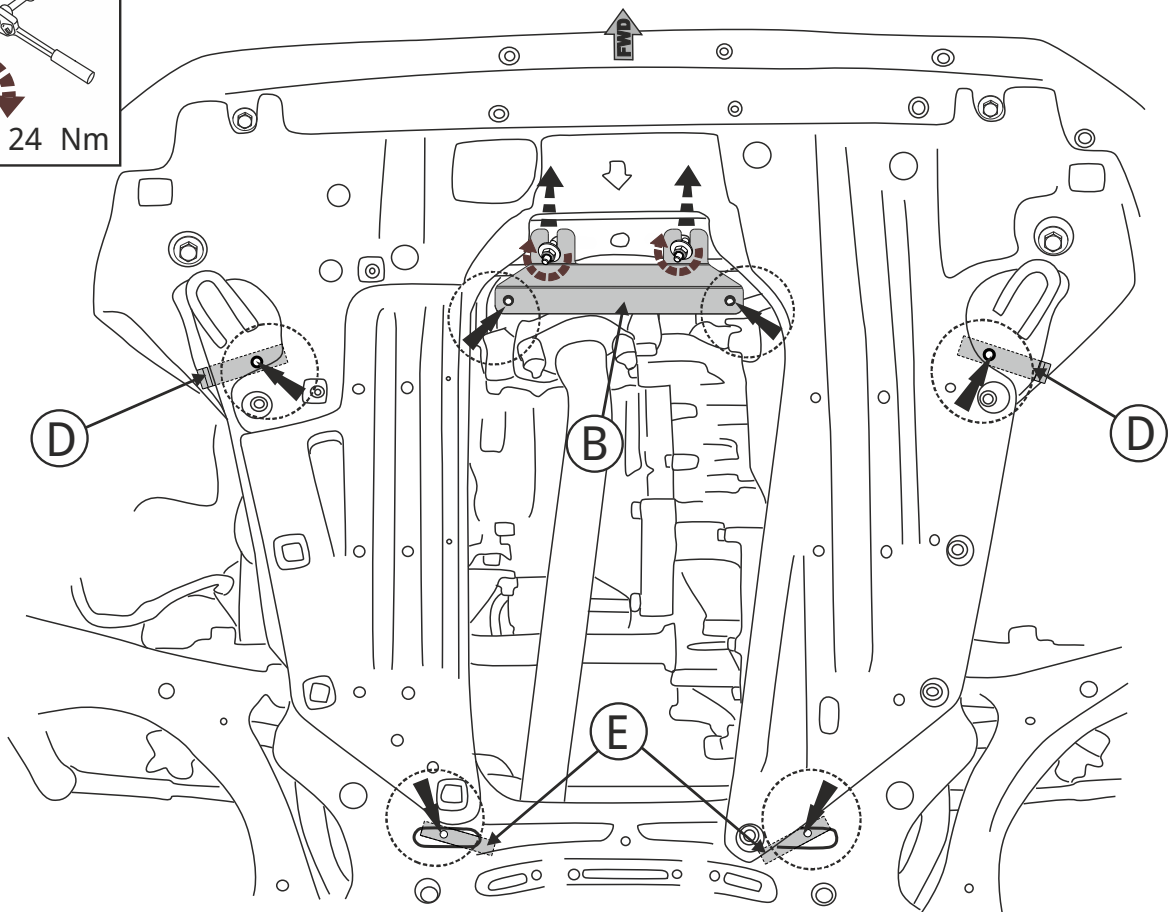
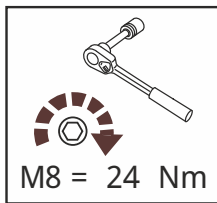

2

