

RU

GB

INSTALLATION MANUAL
SKID PLATE FOR ENGINE BAY



FORD F-150 3,5 AT 4WD

2017- 

08.4868/08.4775

22/03/21

1/6



(RU) /
(GB) Location/Position Arrow

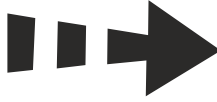

(RU)
(GB) Movement Arrow



(RU)
(GB) Screw Arrow

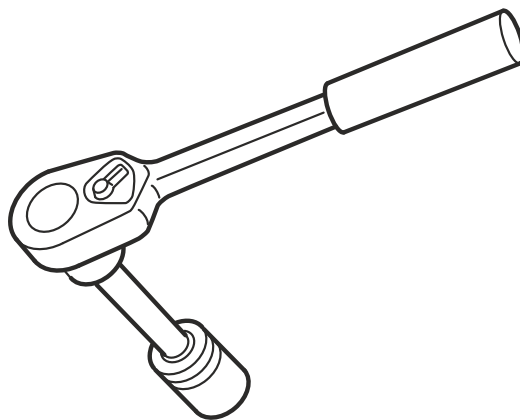
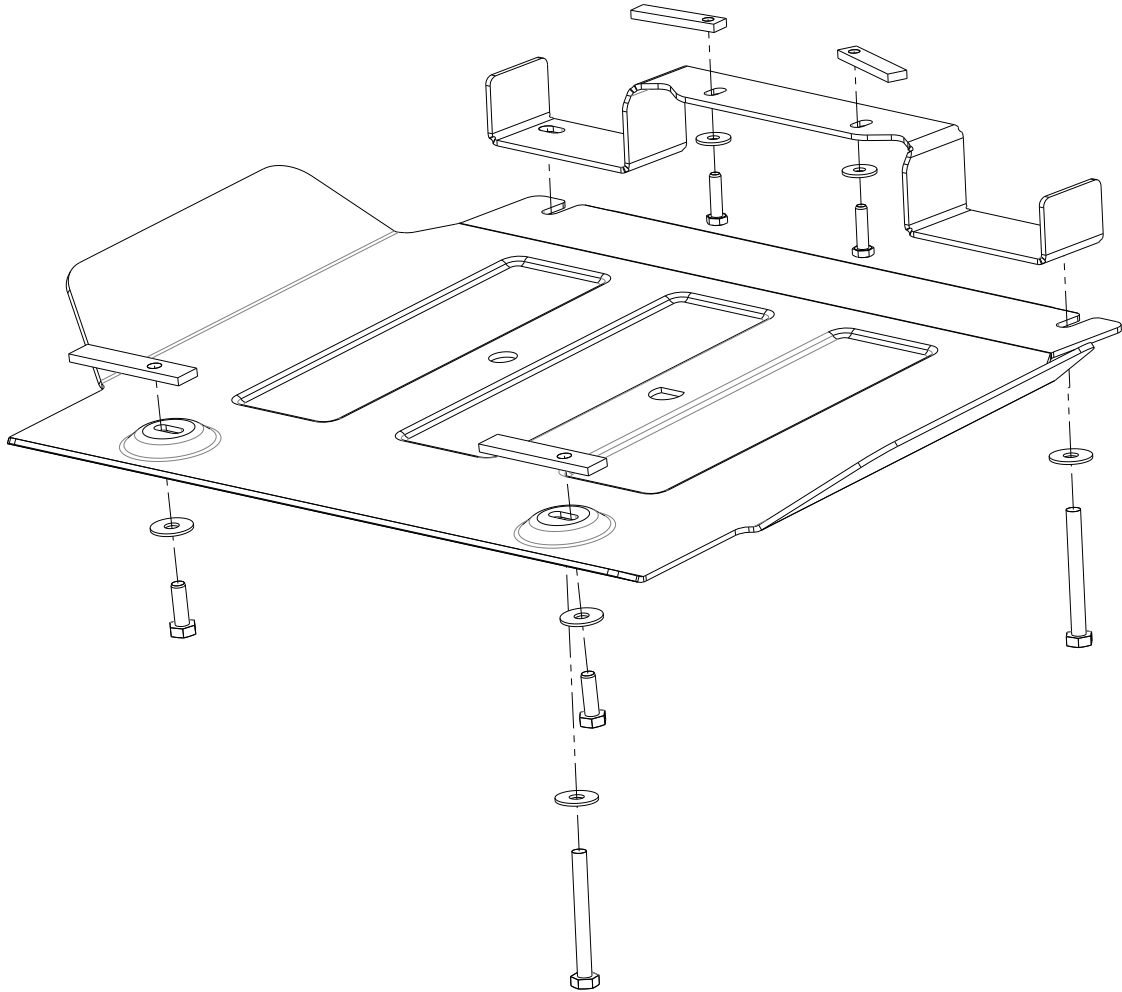

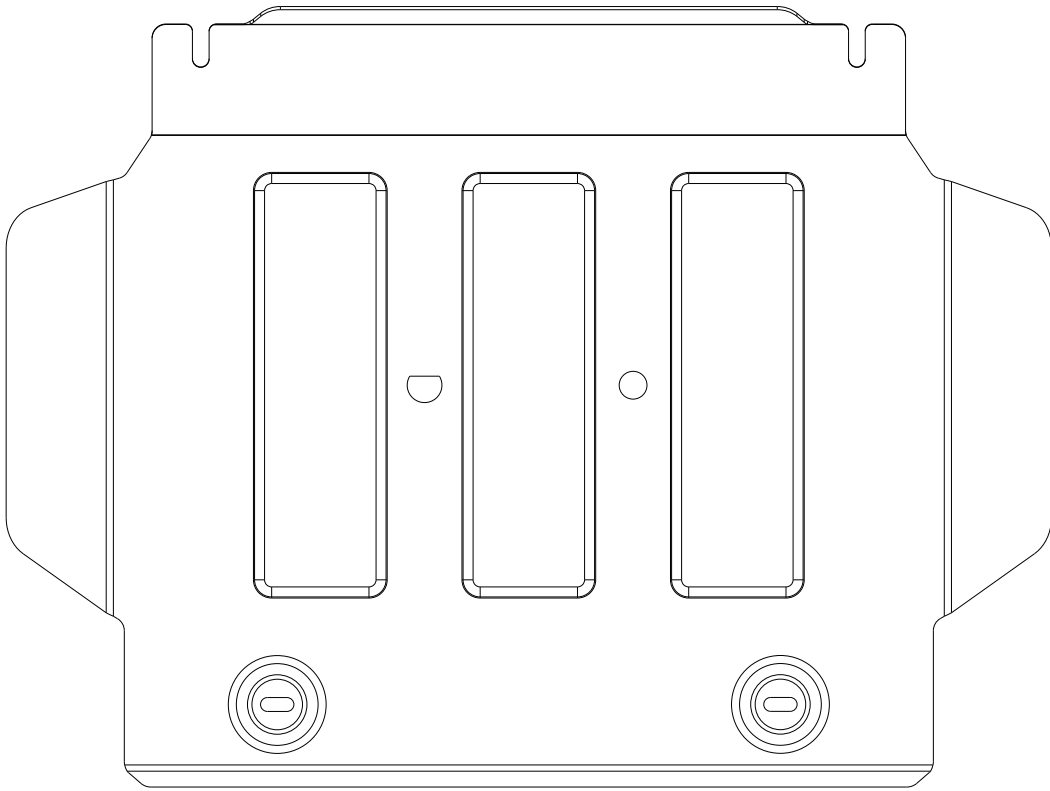
A

1X

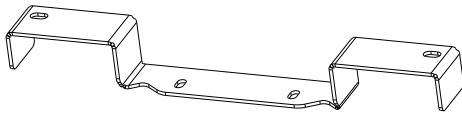
B

1X

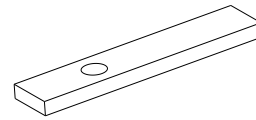
C

3004

2X

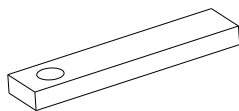
D

3007

2X

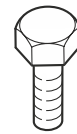
E

M8 30

2X

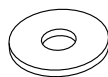
F

Ø8

2X

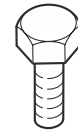
G

M10 30

2X

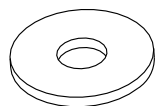
H

Ø10

4X

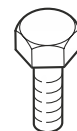
I

M10 90

2X

