

Инструкция по установке

LADA XRAY

(2015-)



Арт.: F.6017.008

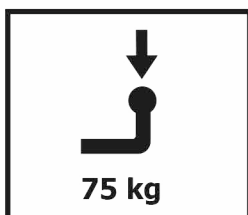
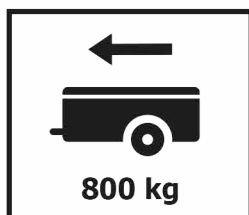

$D = 5,2 \text{ kN}$

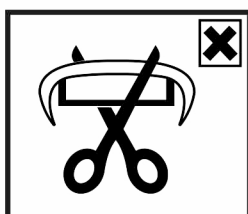

$$D \text{ (kN)} = \frac{\text{MAX kg} \times \text{MAX kg}}{\text{MAX kg} + \text{MAX kg}} \times 0,00981$$

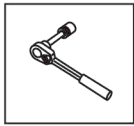

Вкрутить/выкрутить используя инструмент

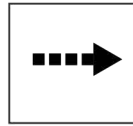

Движение

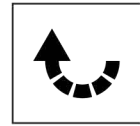

Поворот





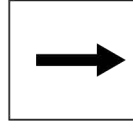



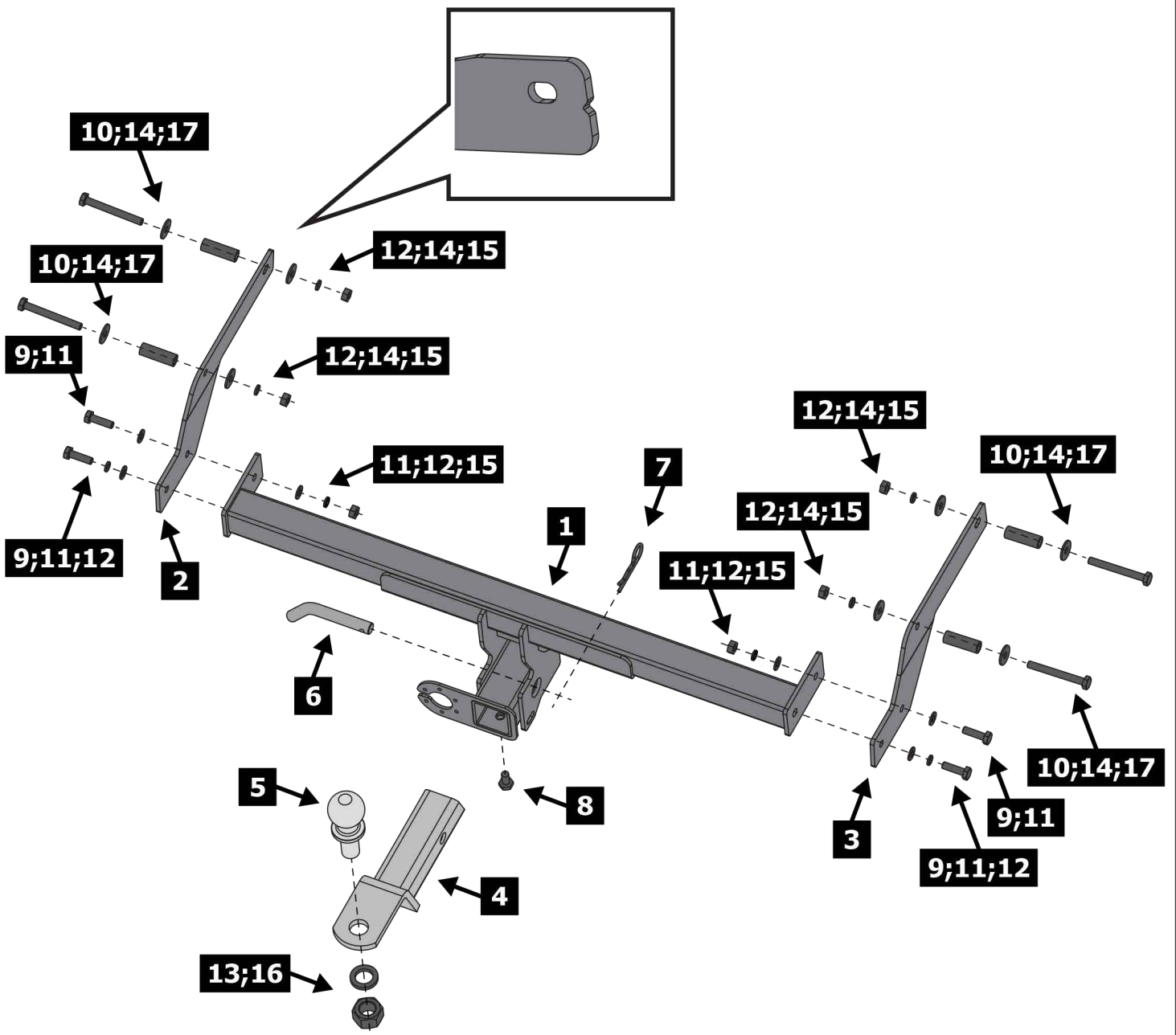
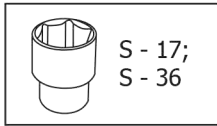
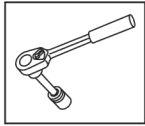

Вкрутить/выкрутить не затягивая

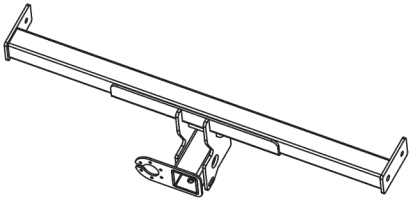
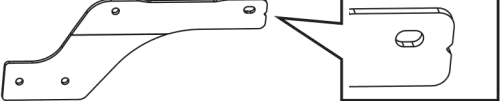
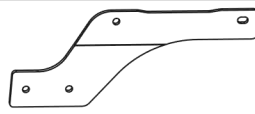
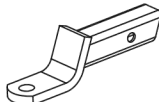
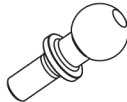
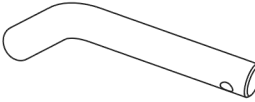
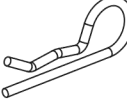
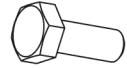
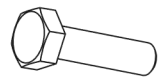
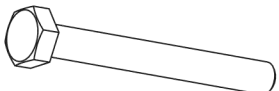

Расположение

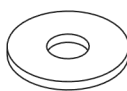
Используемый инструмент:



1	x1	Балка	
2	x1	Кронштейн левый	
3	x1	Кронштейн правый	
4	x1	Переходник	
5	x1	Шар	
6	x1	Штифт	
7	x1	Шплинт	
8	x1	M10x20	
9	x4	M10x35	
10	x4	M10x90	
11	x6	Ø 10	
12	x8	Ø 10	
13	x1	Ø 24	
14	x8	Ø 10 ув.	
15	x6	M10	
16	x1	M24	
17	x4	Втулка	

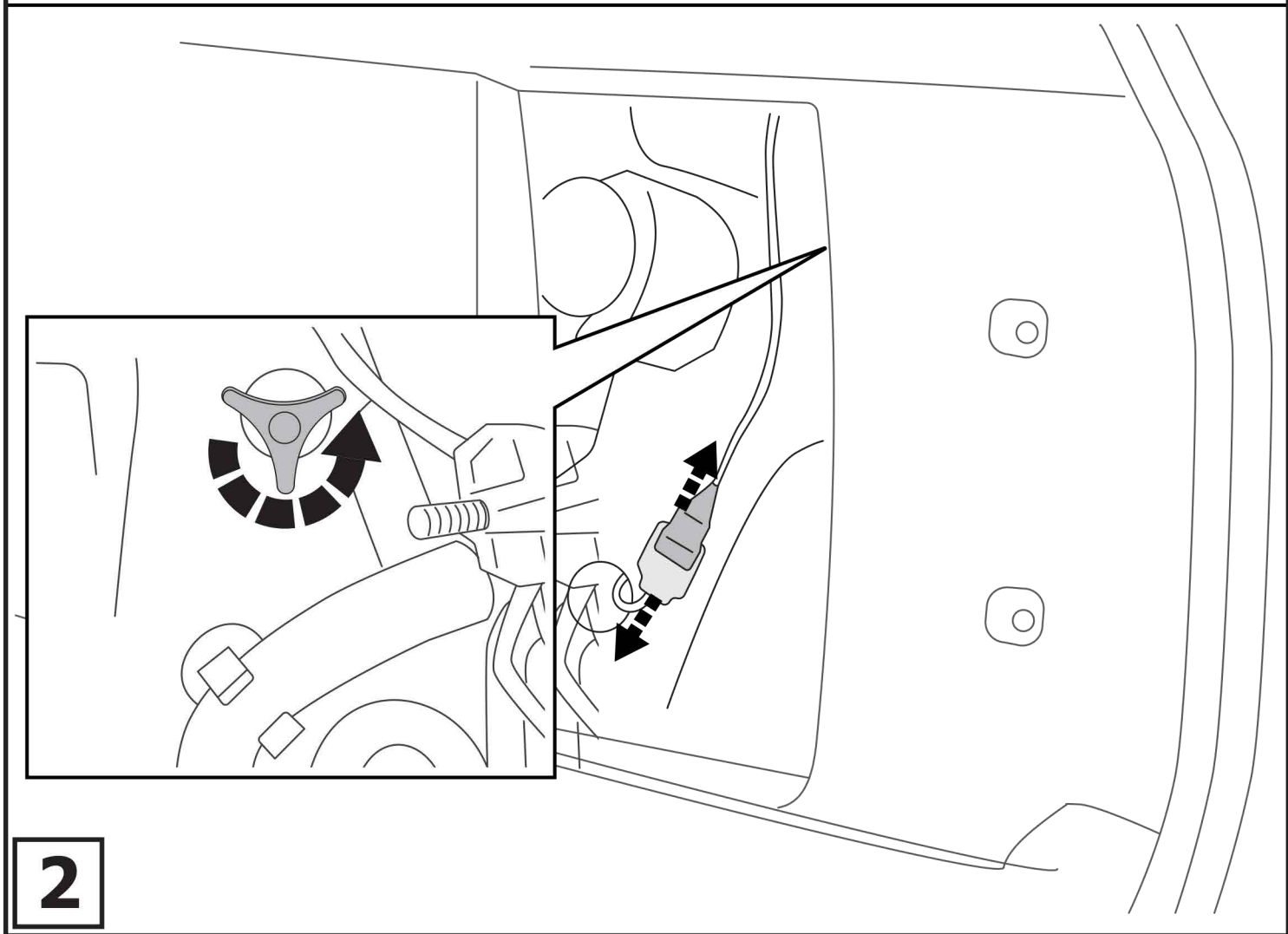
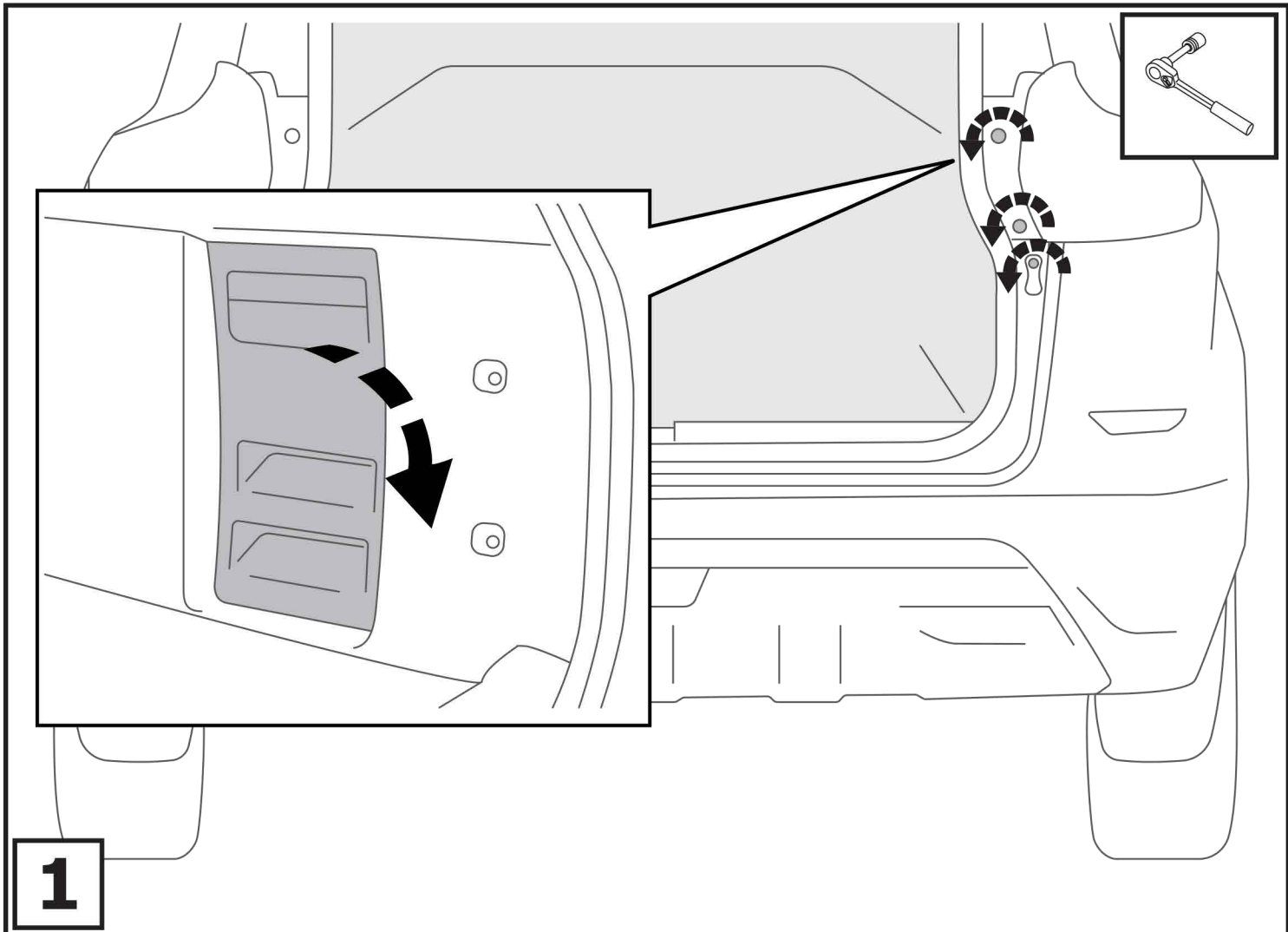

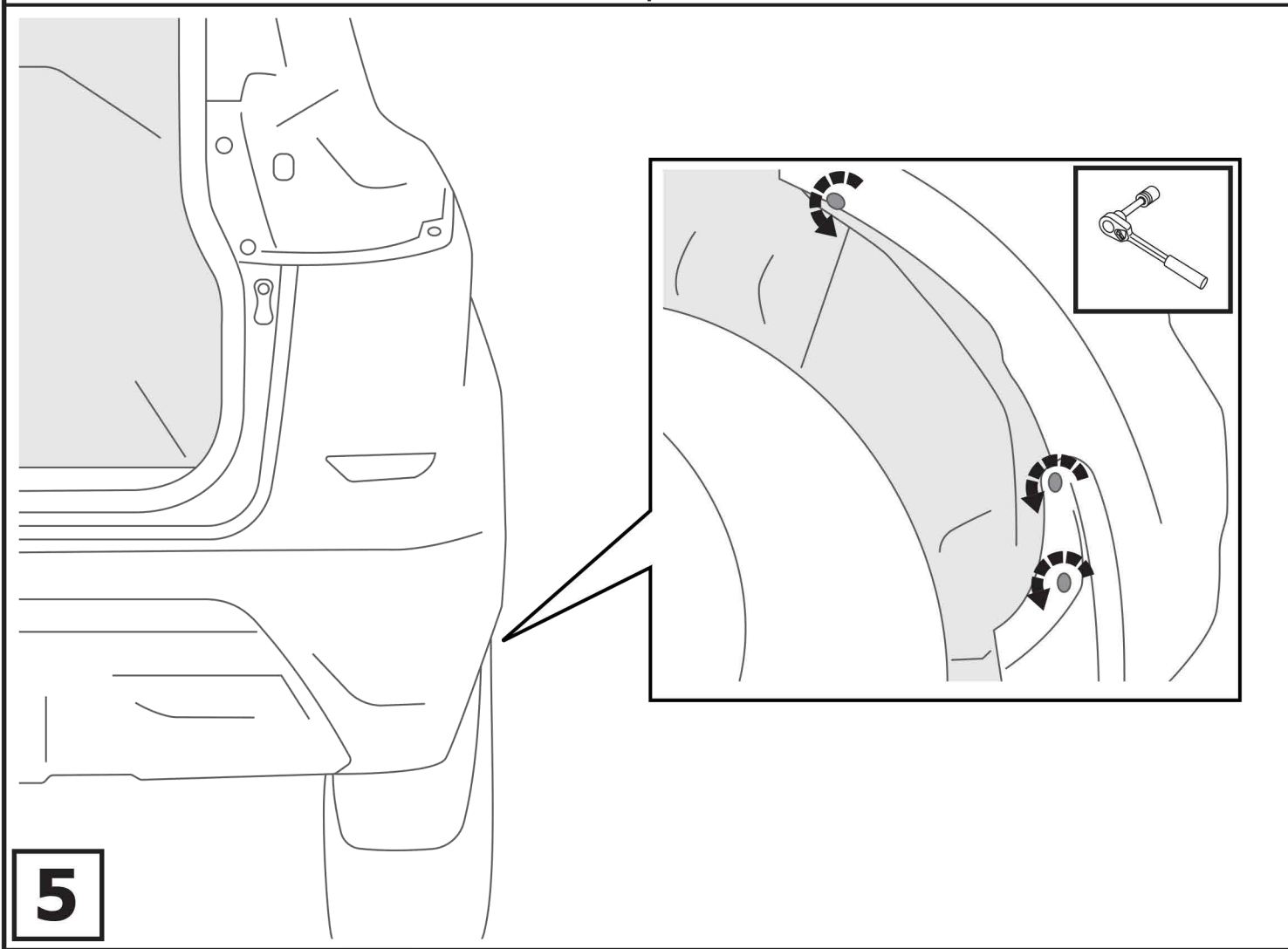
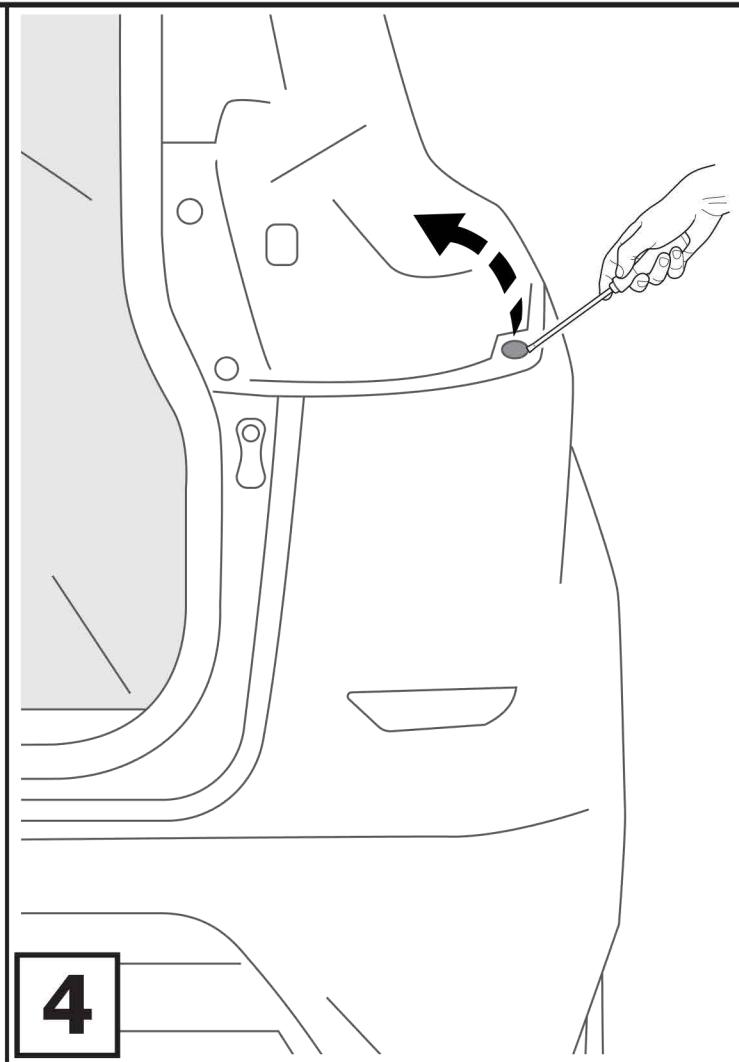
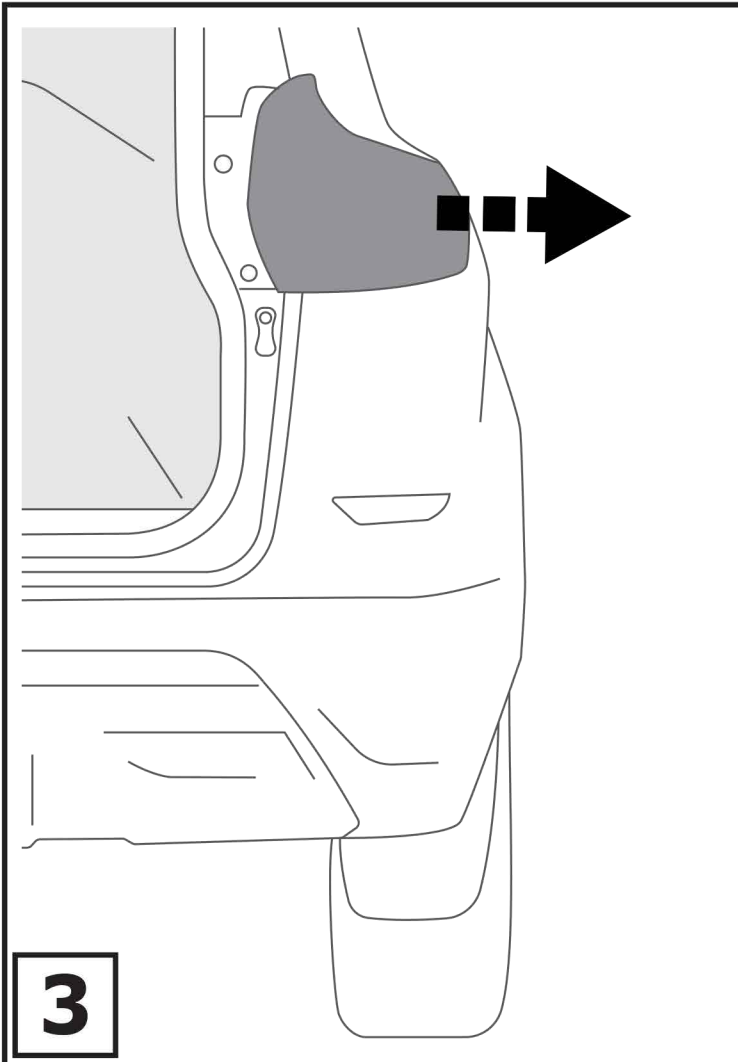

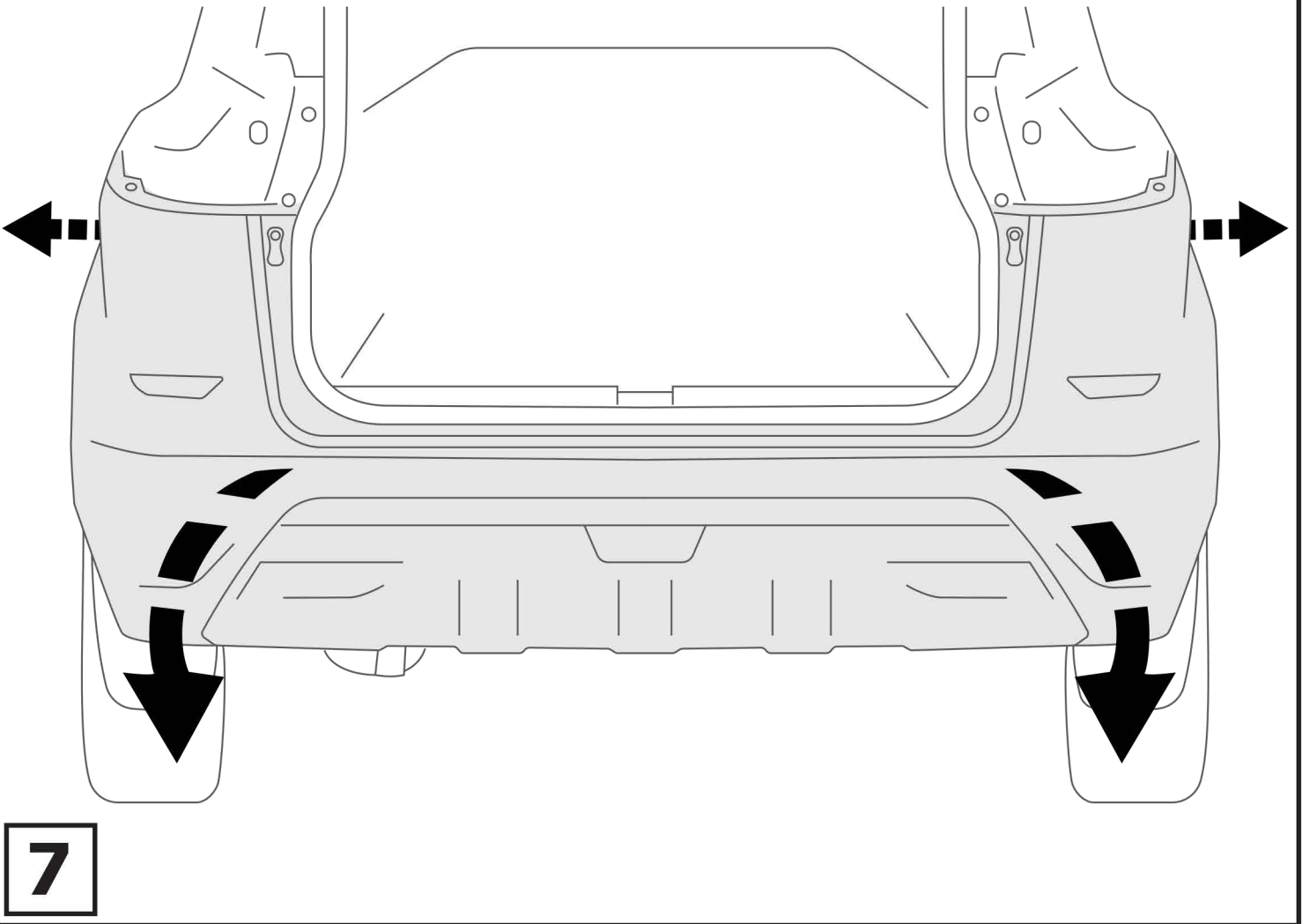
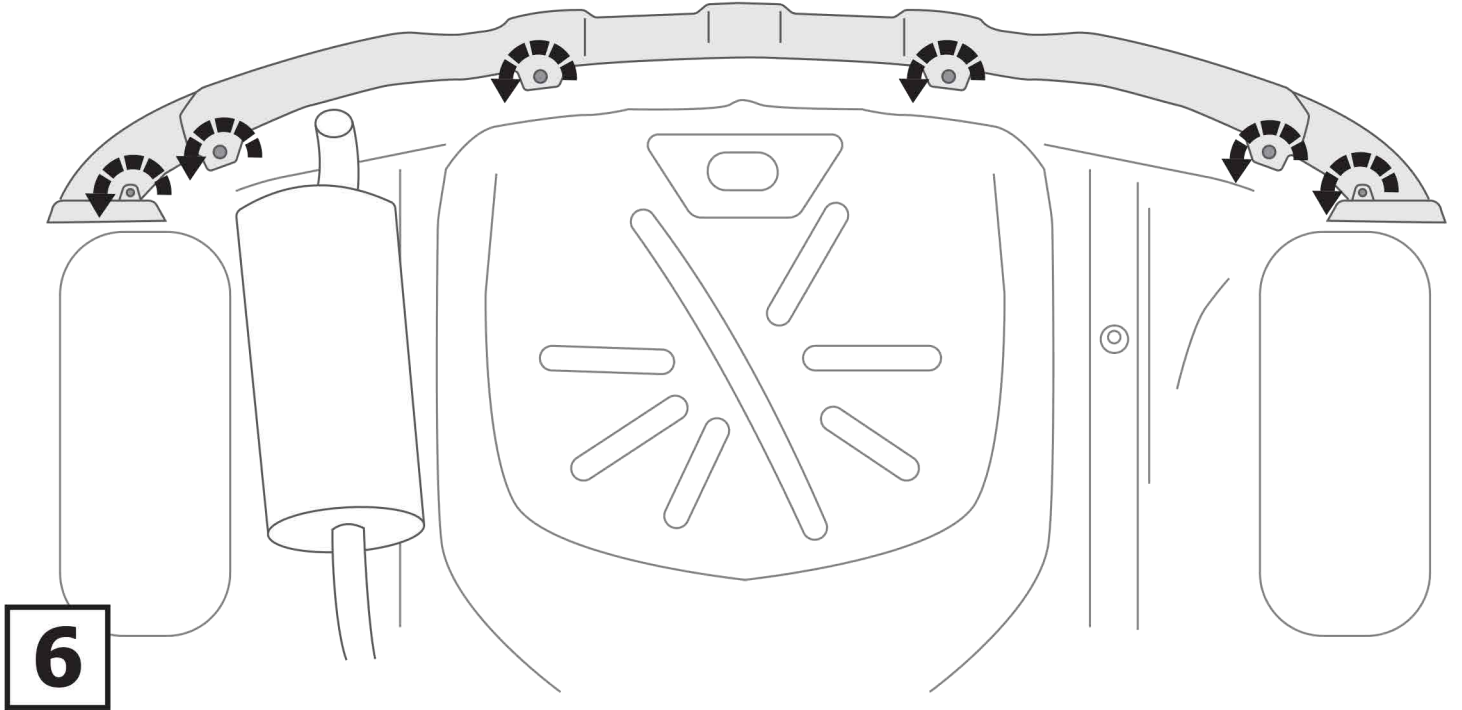
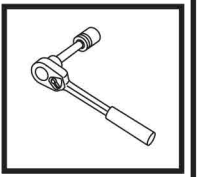
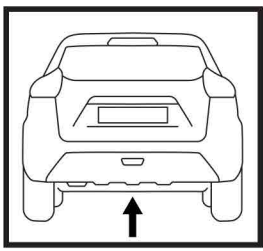

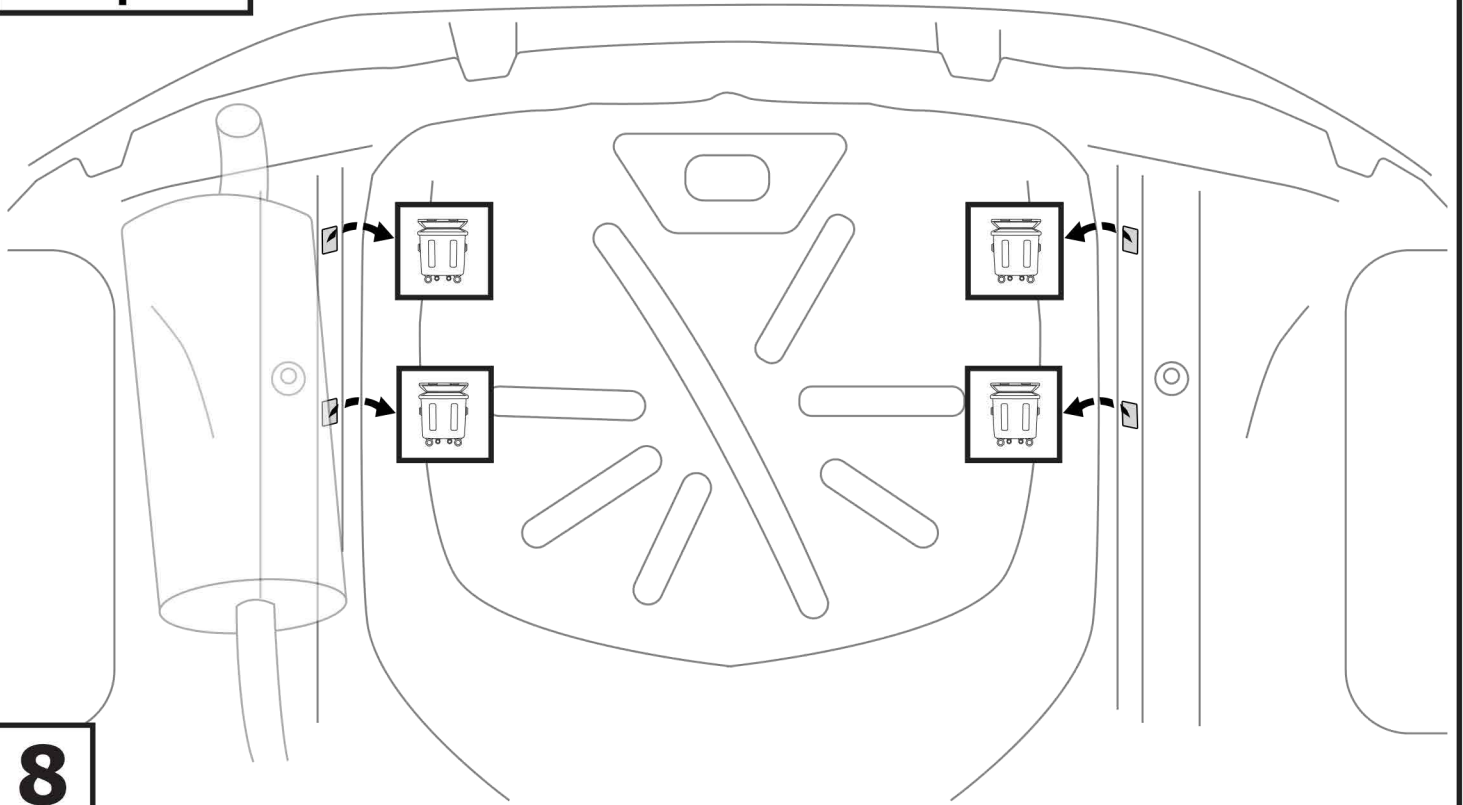
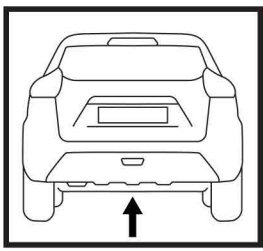

8

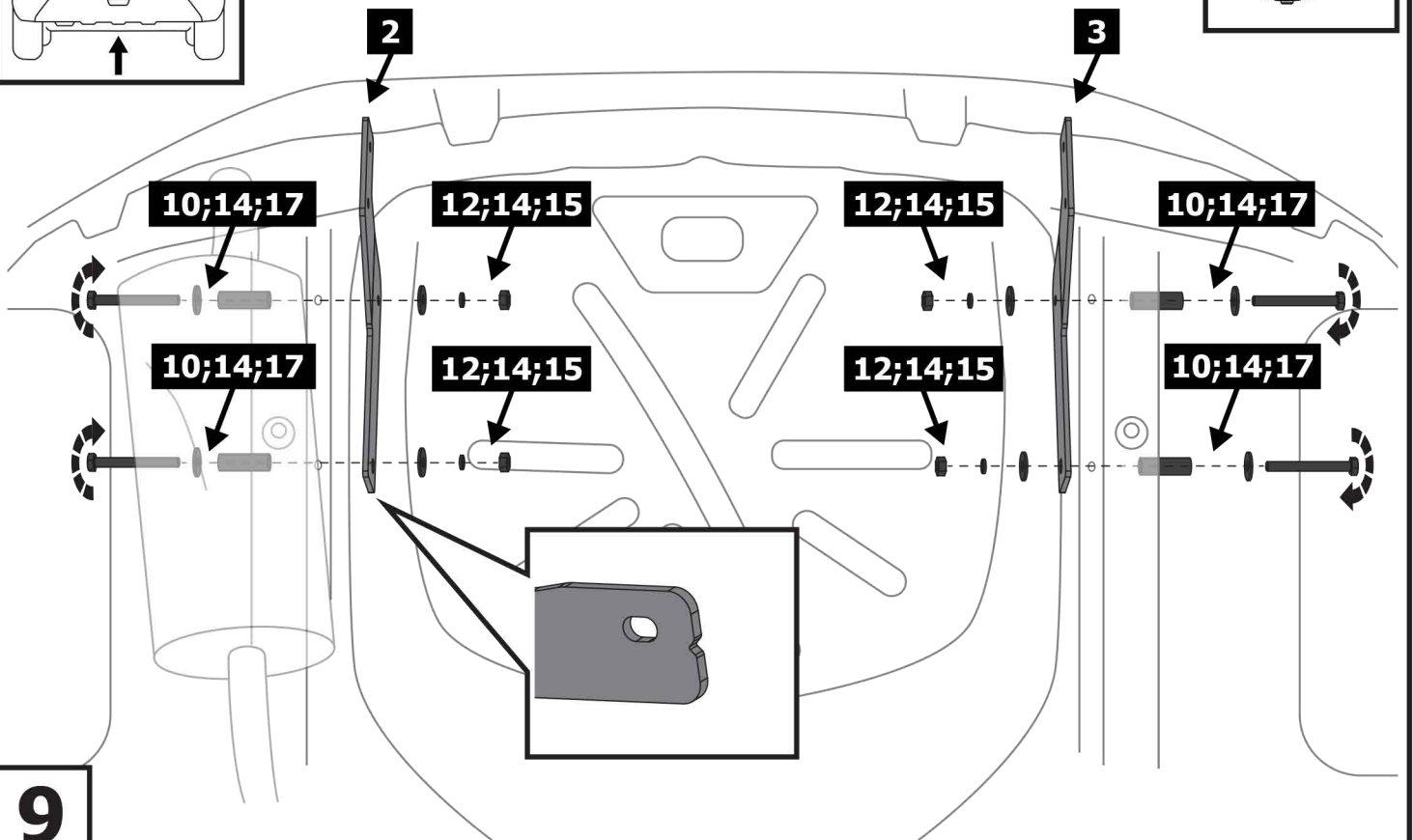
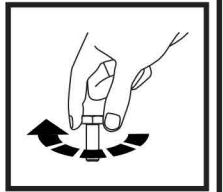
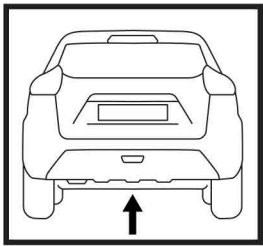

9

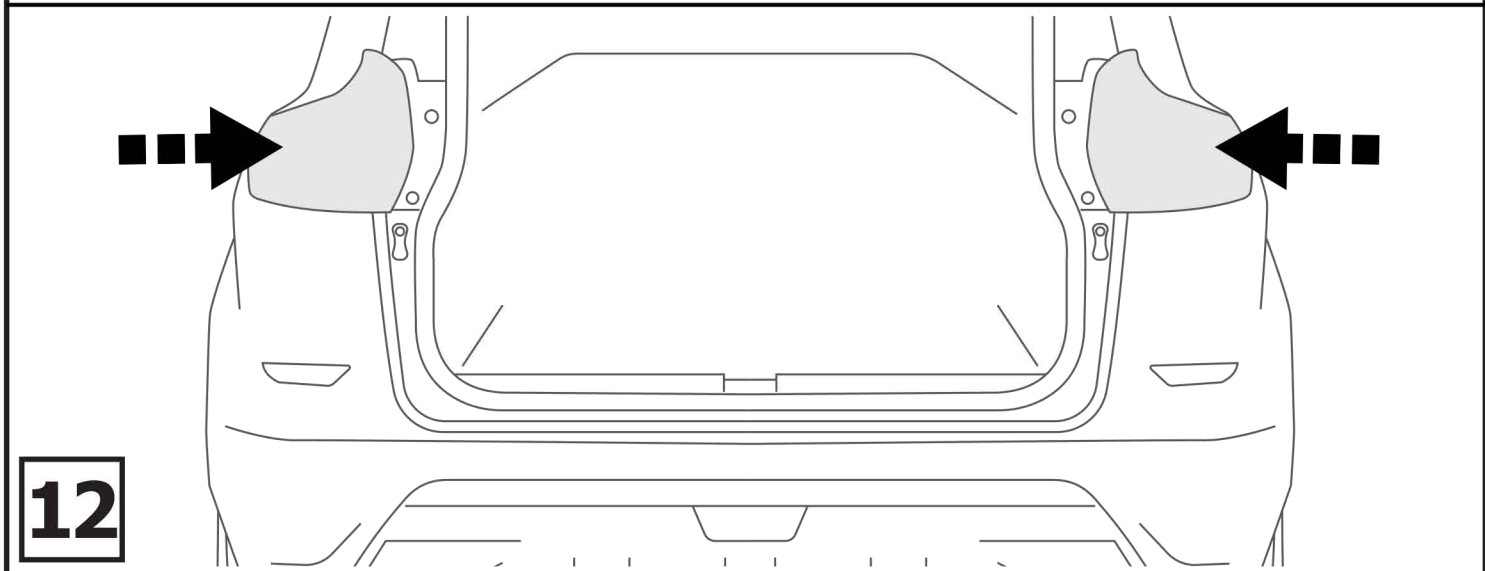
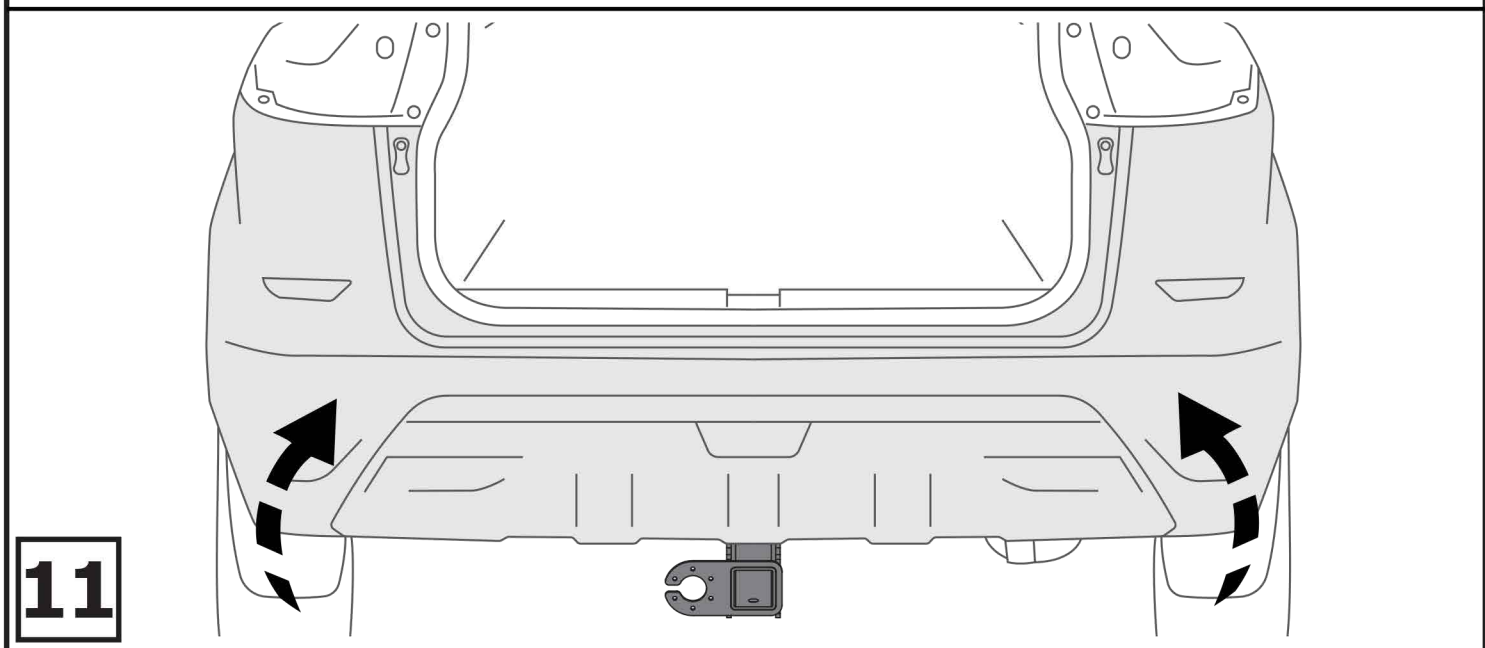
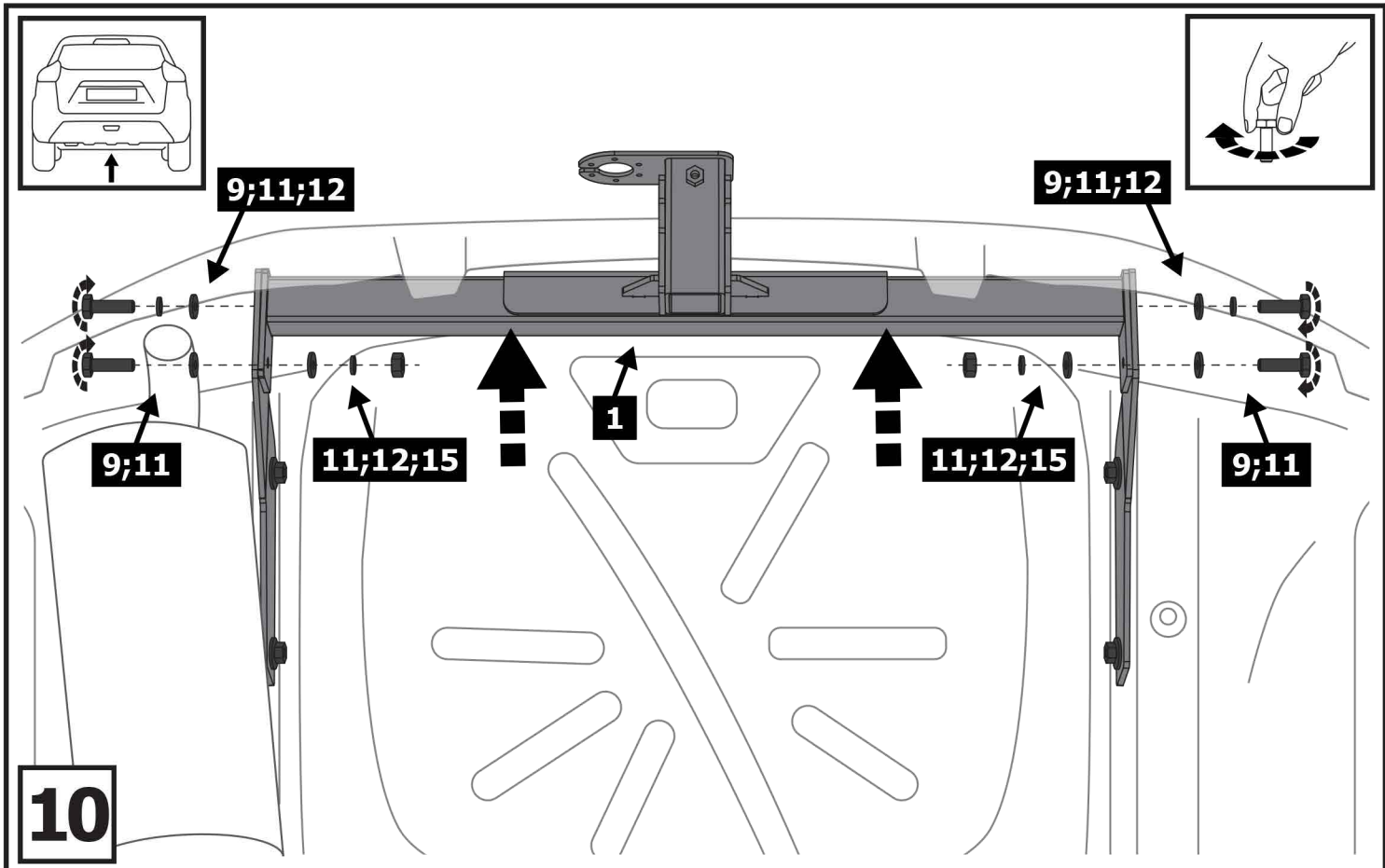



5

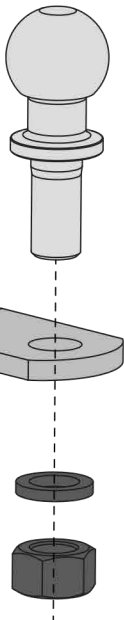

4

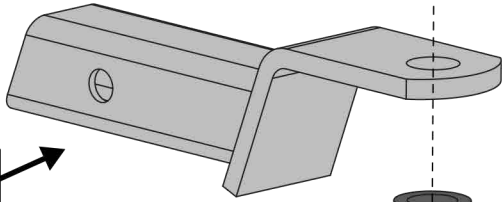

13;16

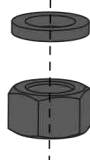

13

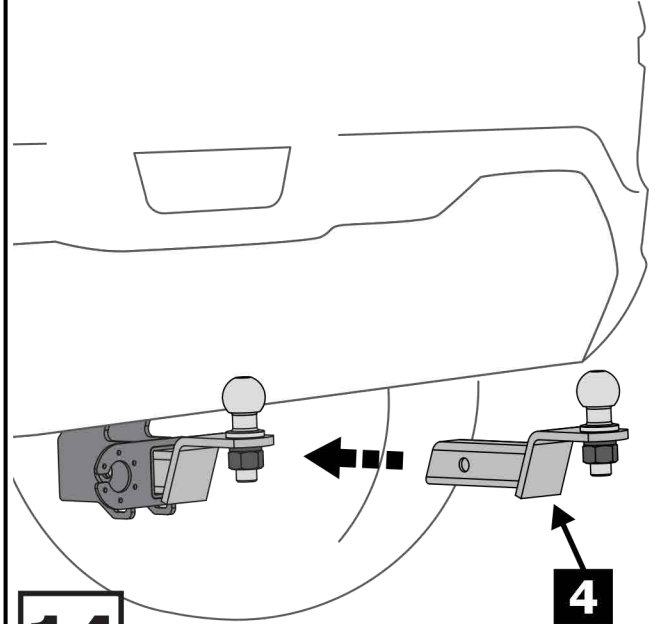

14

4

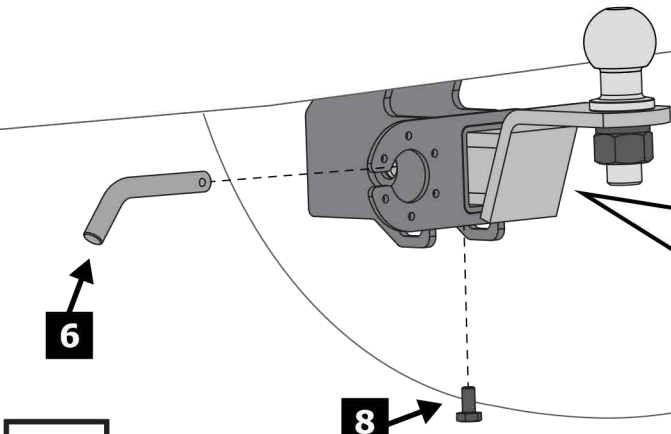
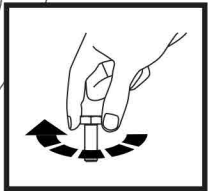

6

8

15

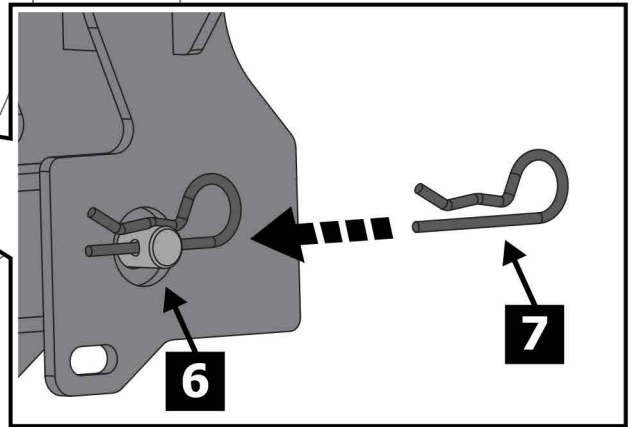

7

6

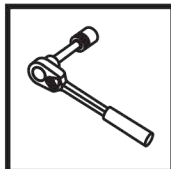
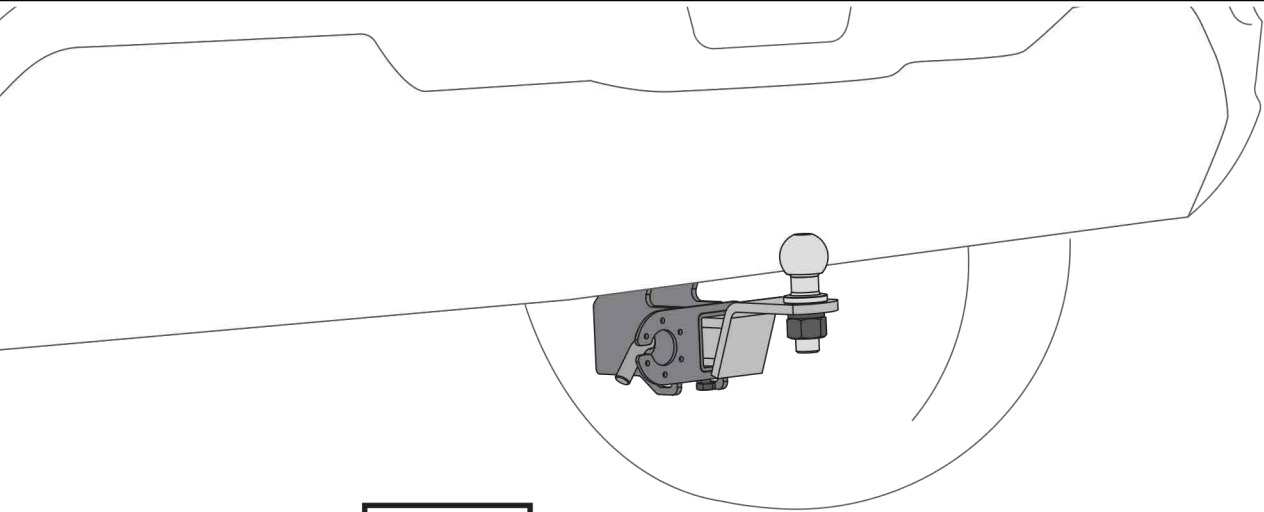

**Затянуть все резьбовые соединения
M10 = 47 Nm; M24 = 95 Nm**