

Инструкция по установке **HYUNDAI CRETA** (2016-)

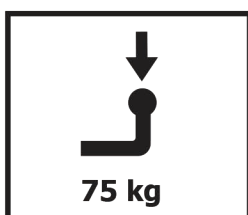

Арт.: F.2312.001

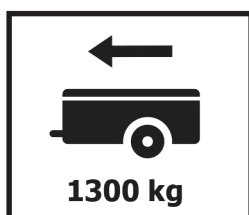

$D = 7.61 \text{ kN}$

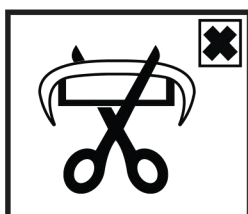

$D \text{ (kN)} = \frac{\text{MAX kg} \times \text{MAX kg}}{\text{MAX kg} + \text{MAX kg}} \times 0,00981$

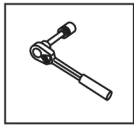

Вкрутить/выкрутить используя инструмент

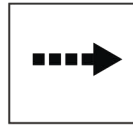

Движение

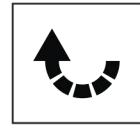

Поворот



Вкрутить/выкрутить не затягивая

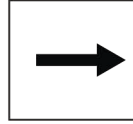





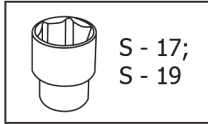
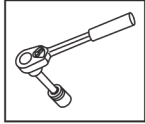

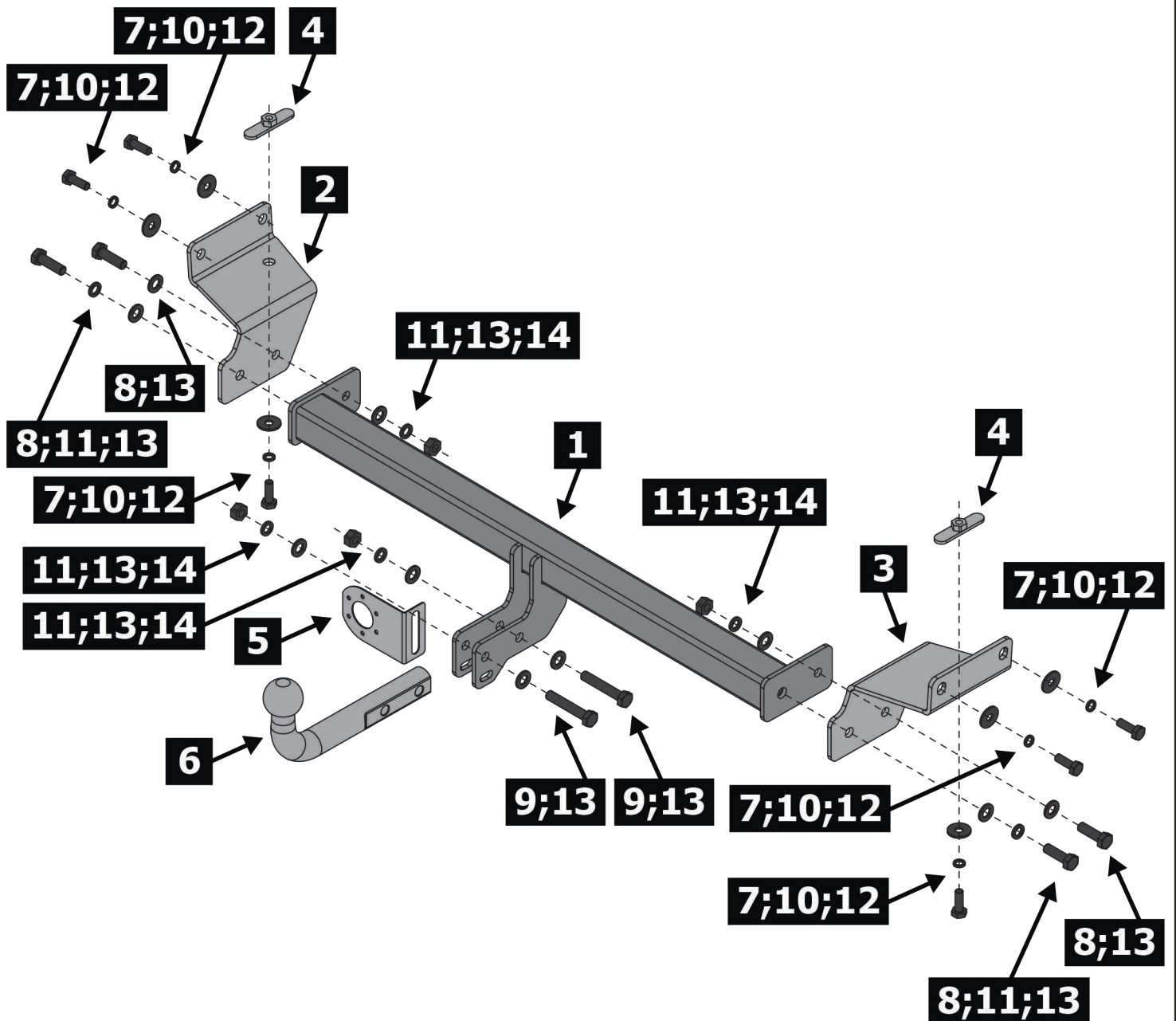

Расположение

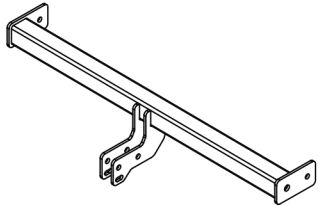
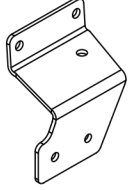
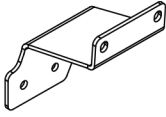
Используемый инструмент:

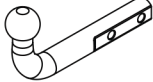
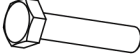

S - 17;
S - 19

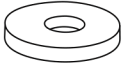

1	x1	Балка	
2	x1	Кронштейн левый	
3	x1	Кронштейн правый	
4	x2	Закладная гайка	
5	x1	Подрозетник	
6	x1	Крюк	
7	x6	M10x1.25x30	
8	x4	M12x1.25x40	
9	x2	M12x1.25x70	
10	x6	∅ 10	
11	x6	∅ 12	
12	x6	∅ 10	
13	x10	∅ 12	
14	x4	M12x1.25	

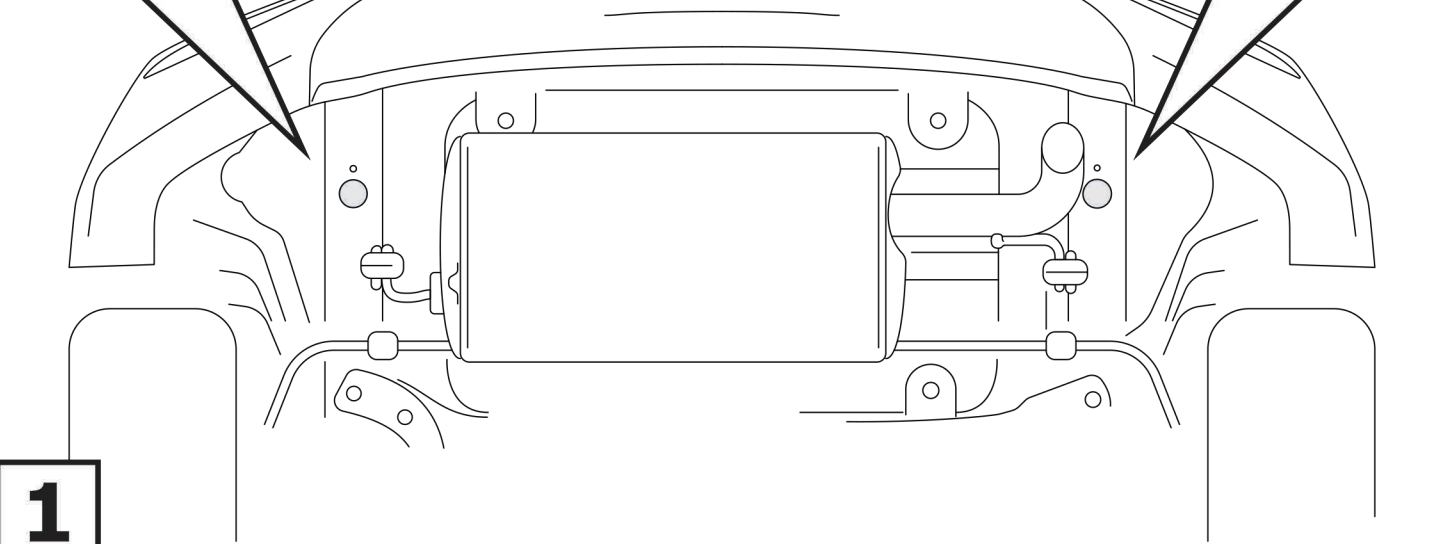
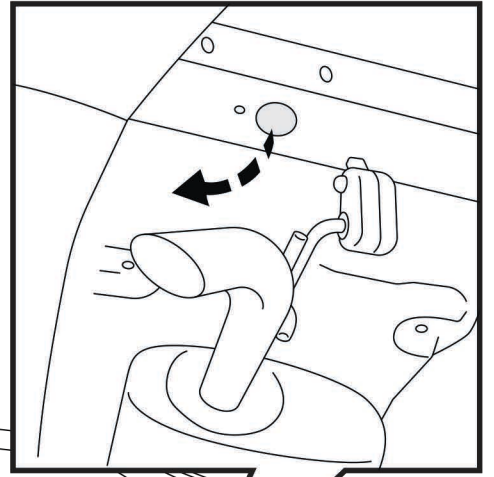
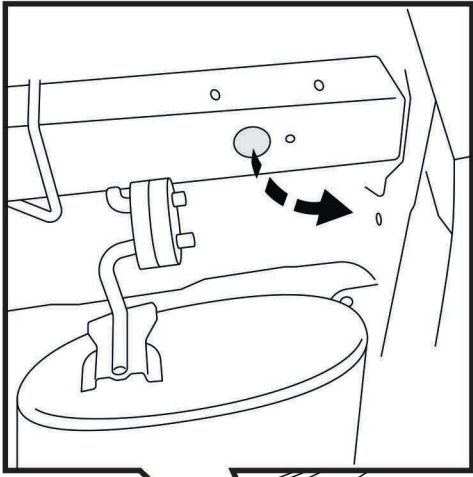

1

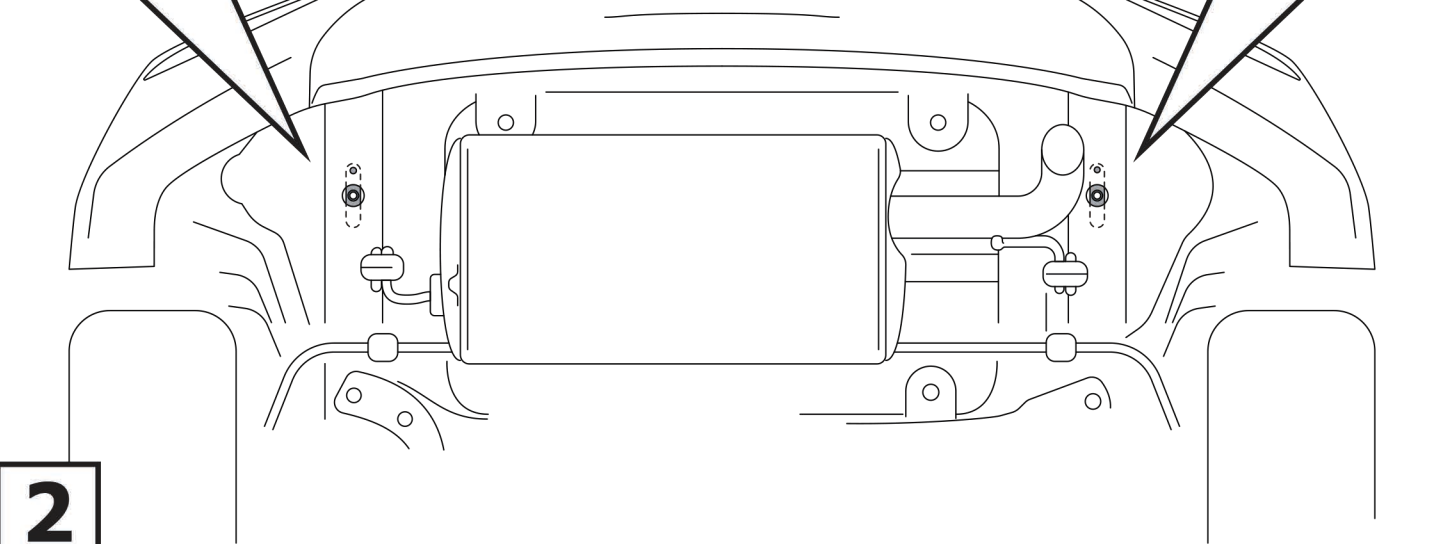
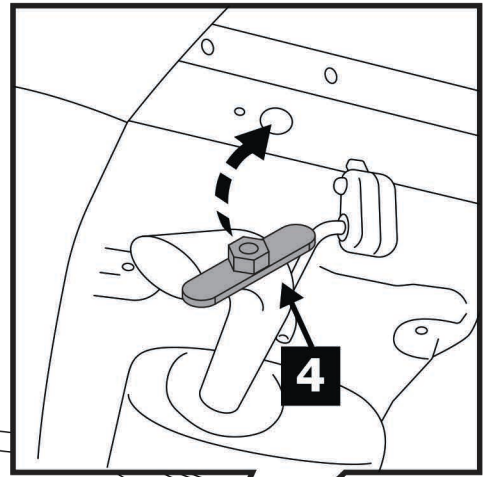
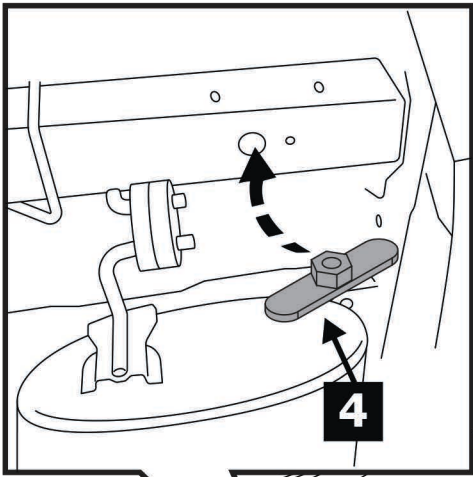

2

