

# Инструкция по установке

## LADA Granta HB

(2019-)



Арт.: F.6017.001

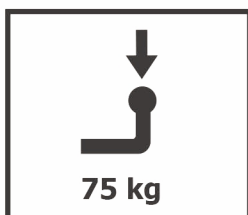
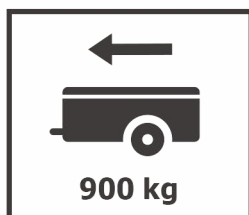

$D = 6,33 \text{ kN}$

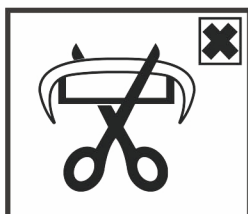

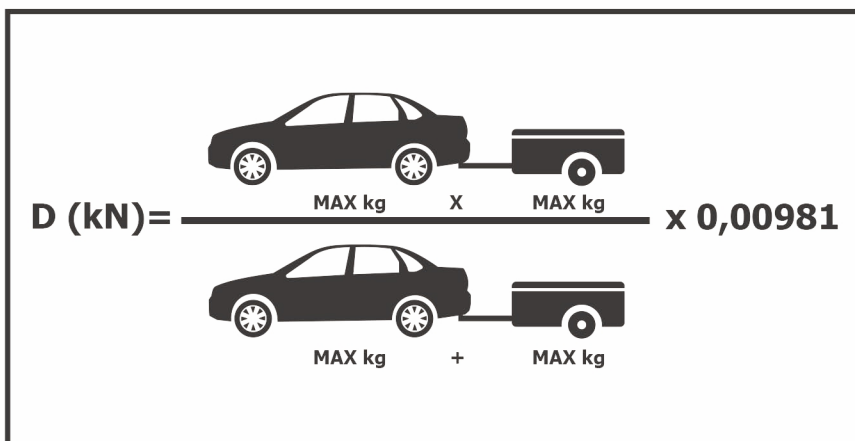
$$D \text{ (kN)} = \frac{\text{MAX kg} \times \text{MAX kg}}{\text{MAX kg} + \text{MAX kg}} \times 0,00981$$

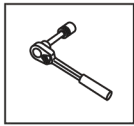

Вкрутить/выкрутить используя инструмент

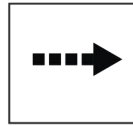

Движение



Поворот



Вкрутить/выкрутить не затягивая

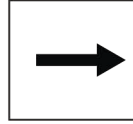





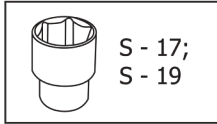
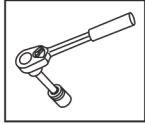

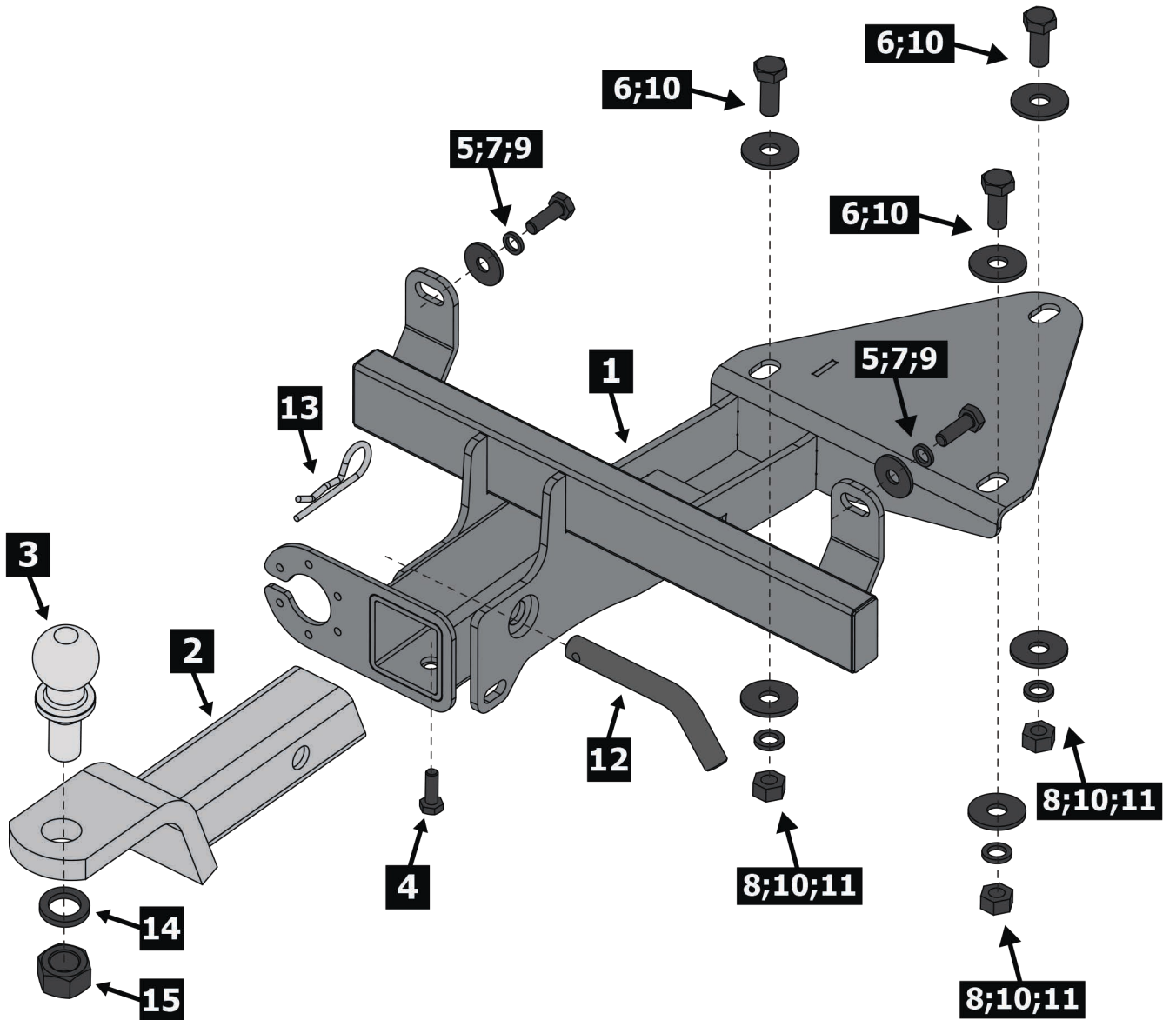

Расположение

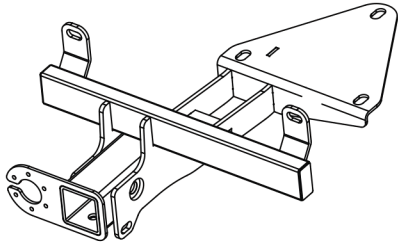
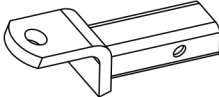
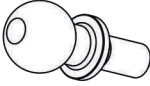
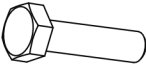
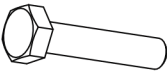
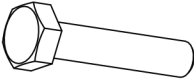
## Используемый инструмент:

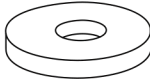
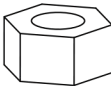

S - 17;  
S - 19

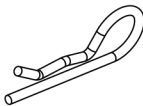

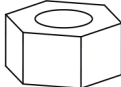
<b>1</b>	x1	Балка	
<b>2</b>	x1	Переходник	
<b>3</b>	x1	Шар	
<b>4</b>	x1	M10x20	
<b>5</b>	x2	M10x1.25x25	
<b>6</b>	x3	M12x30	
<b>7</b>	x2	∅ 10	
<b>8</b>	x3	∅ 12	
<b>9</b>	x2	∅ 10	
<b>10</b>	x6	∅ 12	
<b>11</b>	x3	M12	
<b>12</b>	x1	Штифт	
<b>13</b>	x1	Шплинт	
<b>14</b>	x1	∅24	
<b>15</b>	x1	M24	

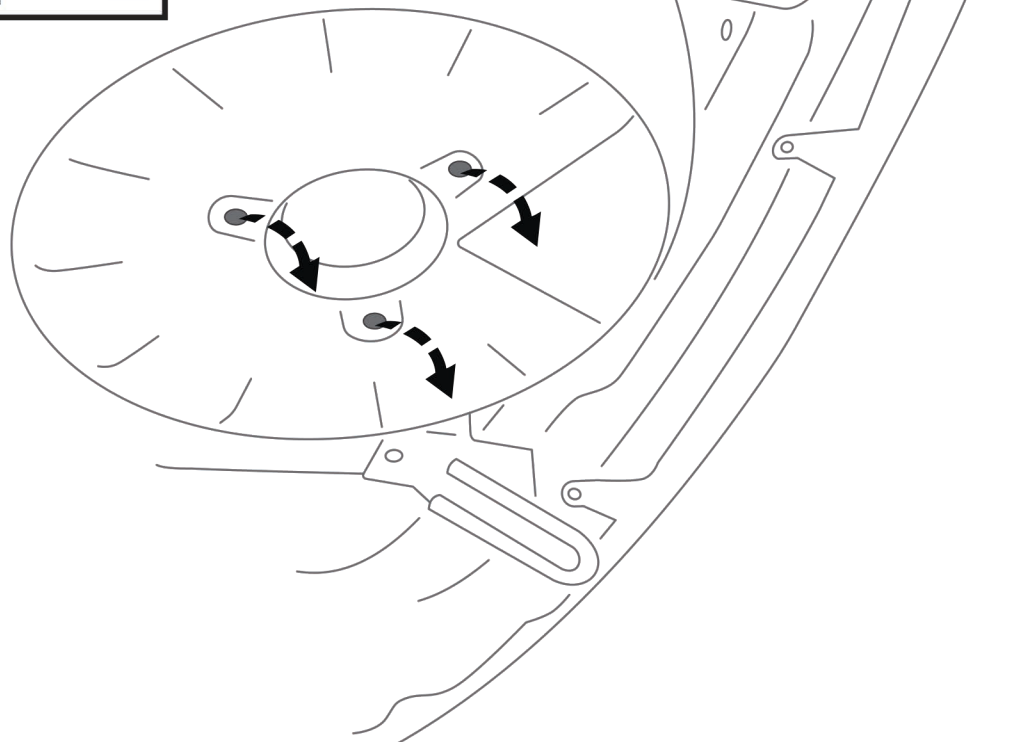
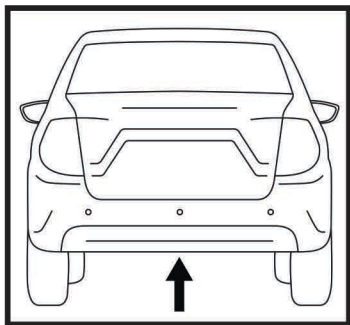

**1**

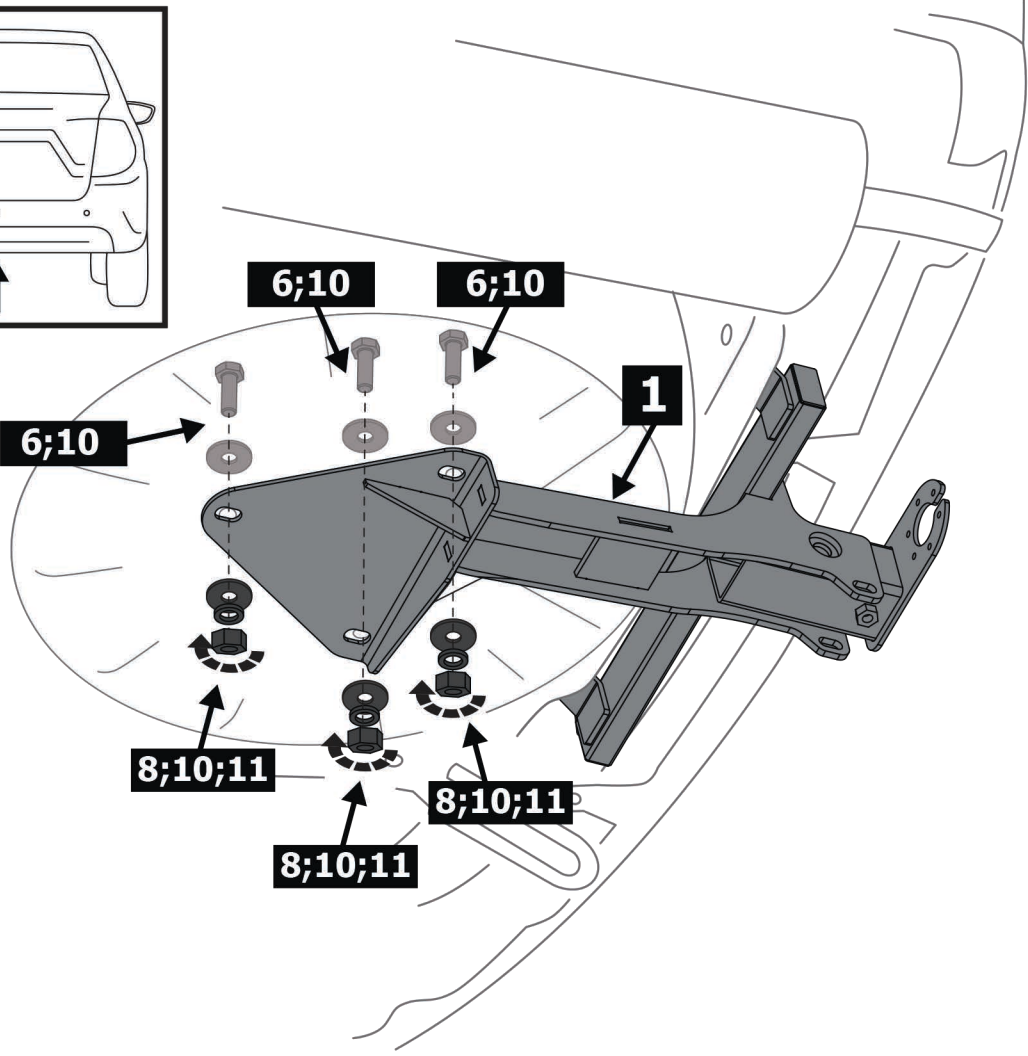
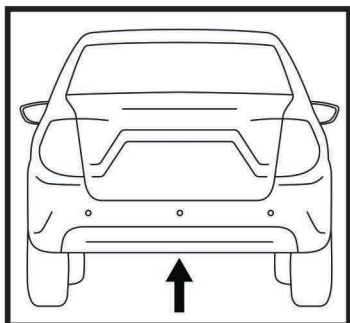

**2**

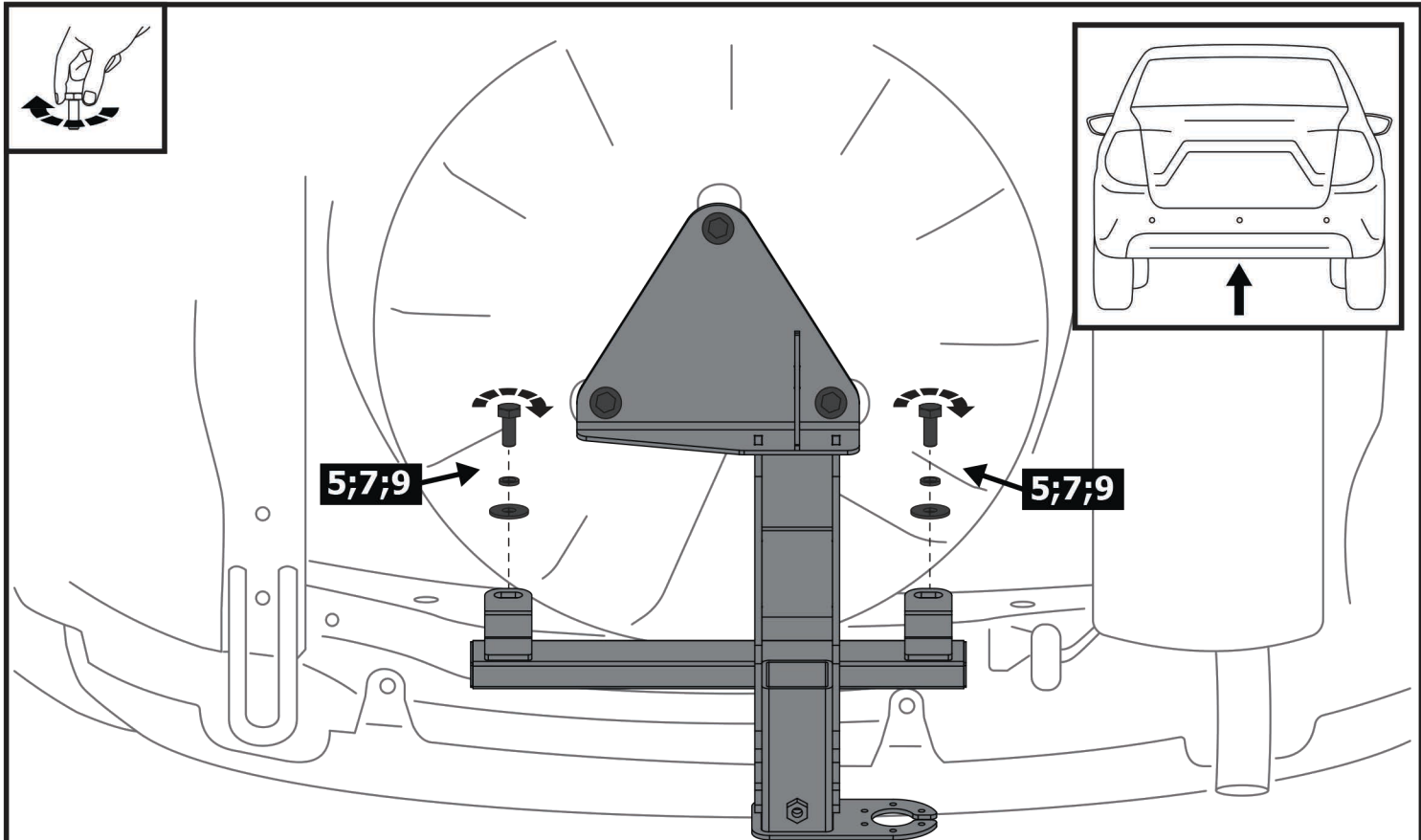

**3**

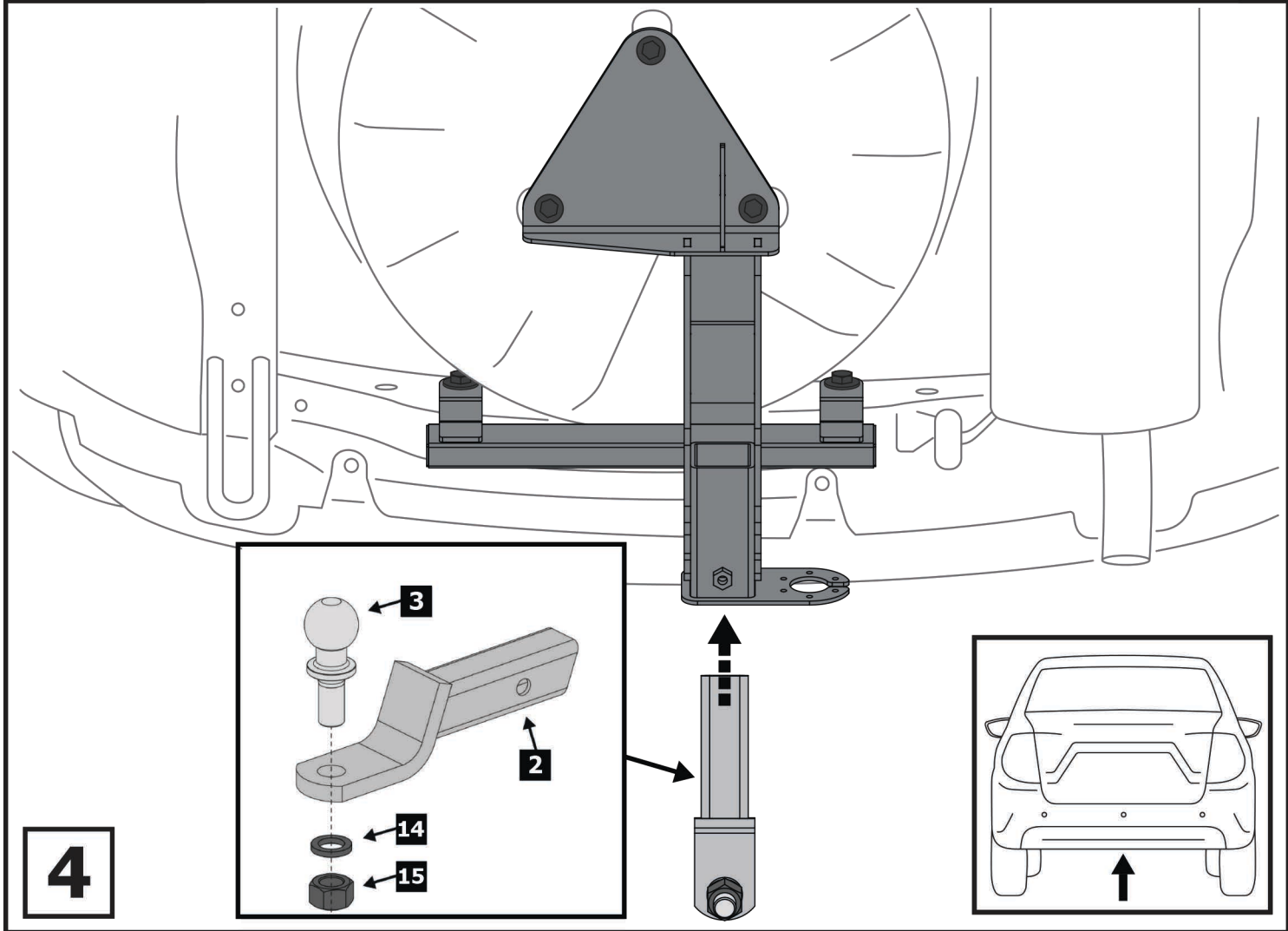

**4**

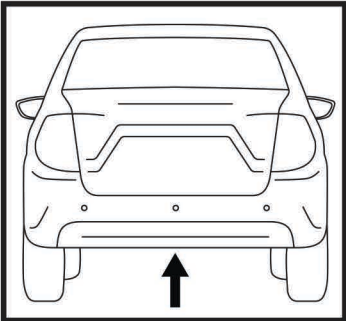
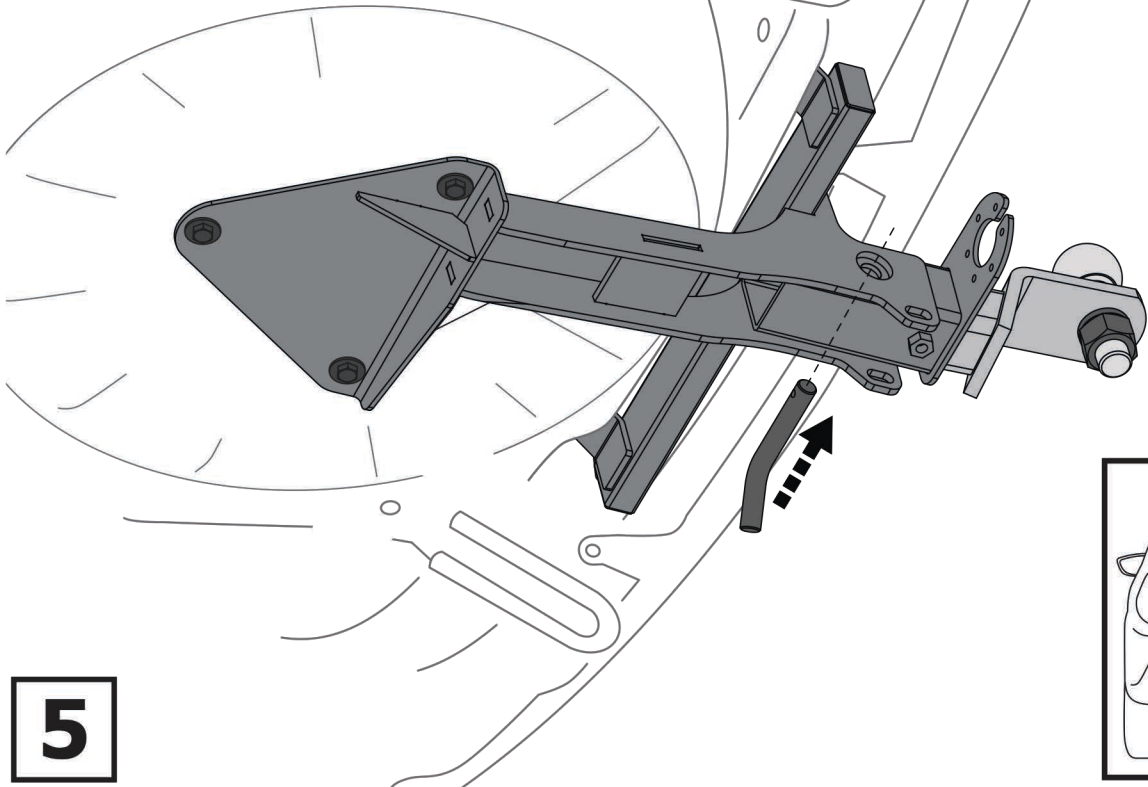
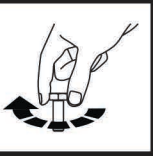

**5**

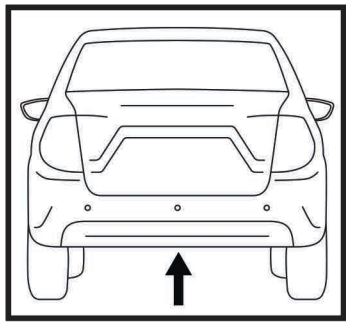
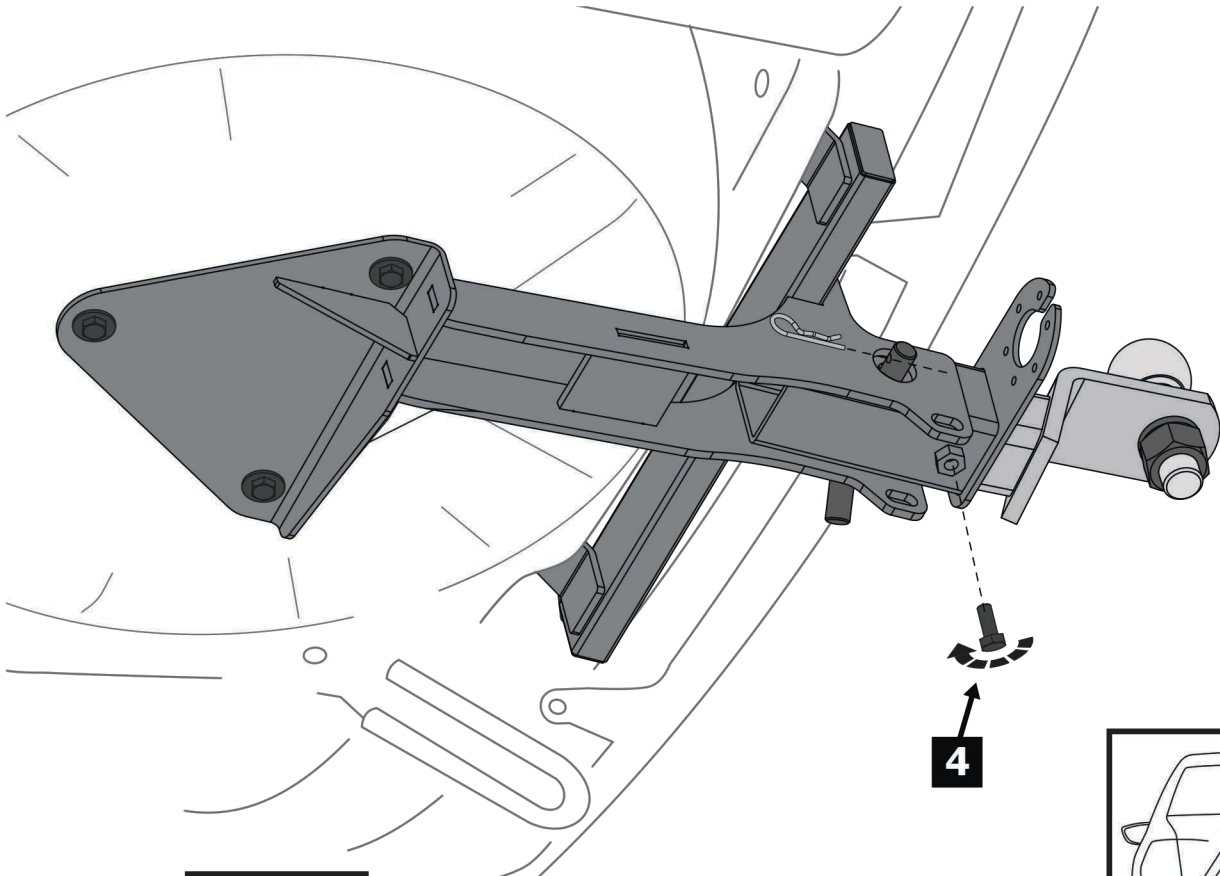

**4**

**6**

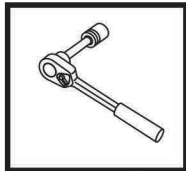

**Затянуть все резьбовые соединения**  
**M10 = 47 Nm M12 = 81 Nm**