



Инструкция по установке  
**TOYOTA RAV4**  
 (20013-2019)



Арт.: F.5711.001

 <p>1200 kg</p>	 <p>75 kg</p>	 $D \text{ (kN)} = \frac{\text{MAX kg} \times \text{MAX kg}}{\text{MAX kg} + \text{MAX kg}} \times 0,00981$
<p>D = 6.7 kN</p>		

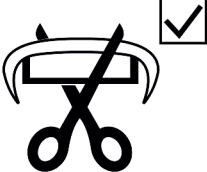
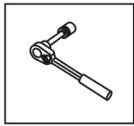

Вкрутить/выкрутить используя инструмент

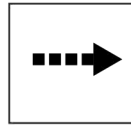

Движение

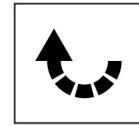

Поворот



Вкрутить/выкрутить не затягивая

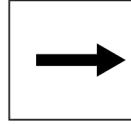





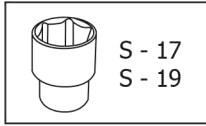
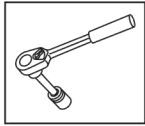



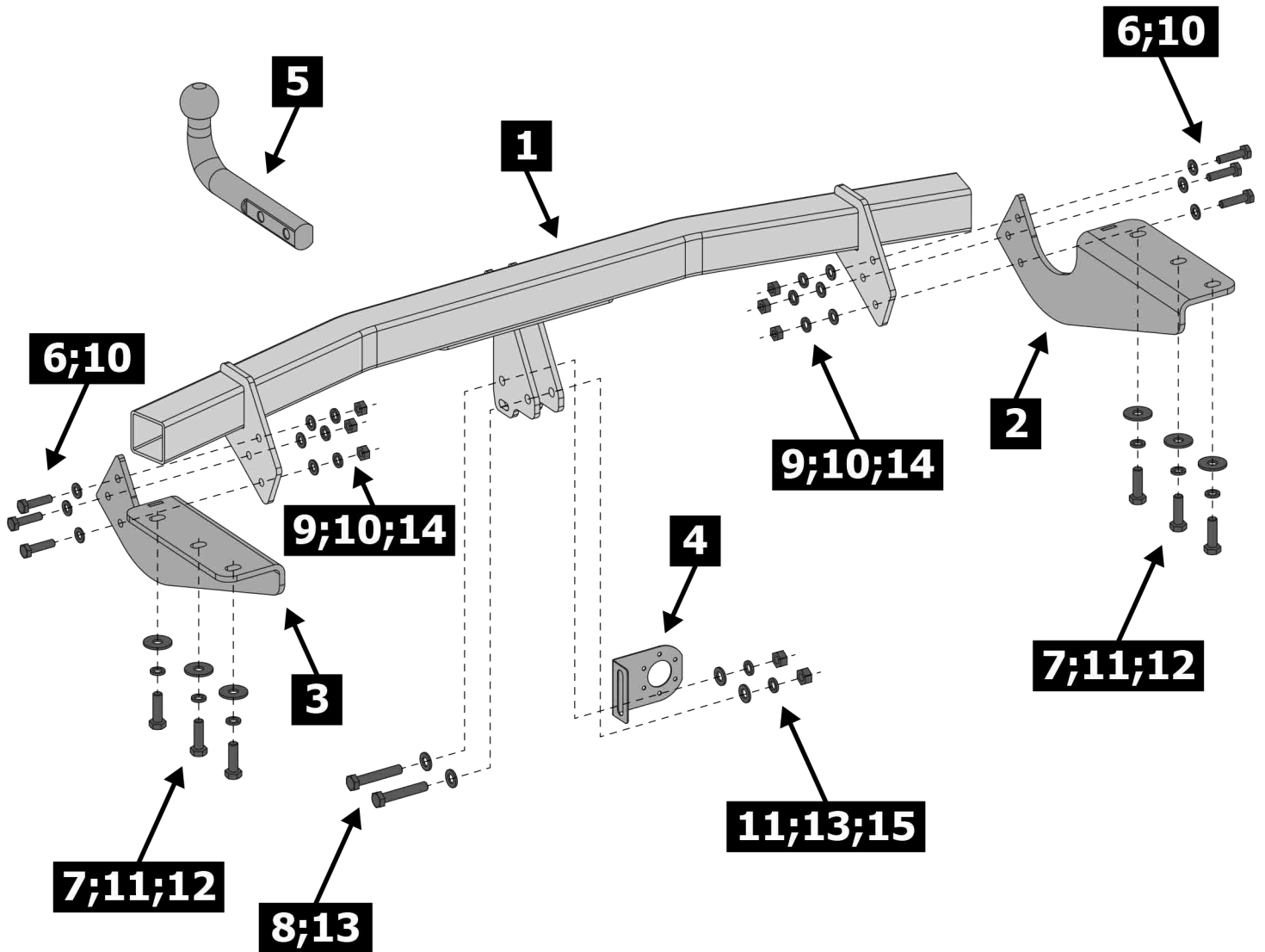

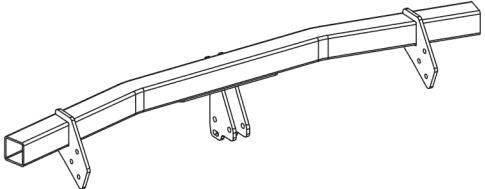
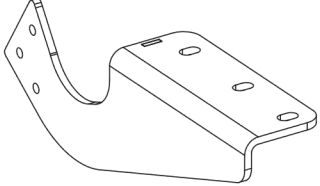
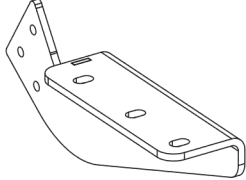
Расположение

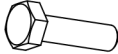
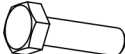
### Используемый инструмент:



S - 17  
S - 19

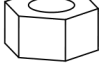

<b>1</b>	x1	Балка	
<b>2</b>	x1	Кронштейн левый	
<b>3</b>	x1	Кронштейн правый	
<b>4</b>	x1	Подрозетник	
<b>5</b>	x1	Крюк	
<b>6</b>	x6	M10x40	
<b>7</b>	x6	M12x40	
<b>8</b>	x2	M12x70	
<b>9</b>	x6	∅ 10	
<b>10</b>	x12	∅ 10	
<b>11</b>	x7	∅ 12	
<b>12</b>	x5	∅ 12	
<b>13</b>	x4	∅ 12	
<b>14</b>	x6	M10	
<b>15</b>	x2	M12x1.25	

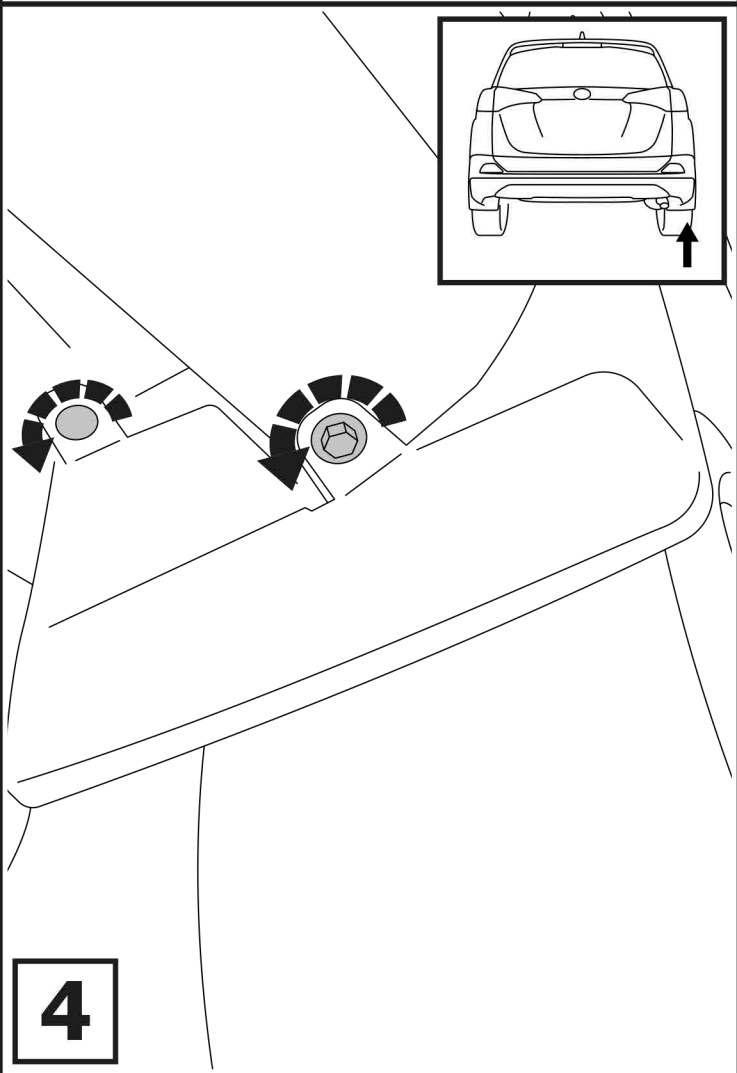
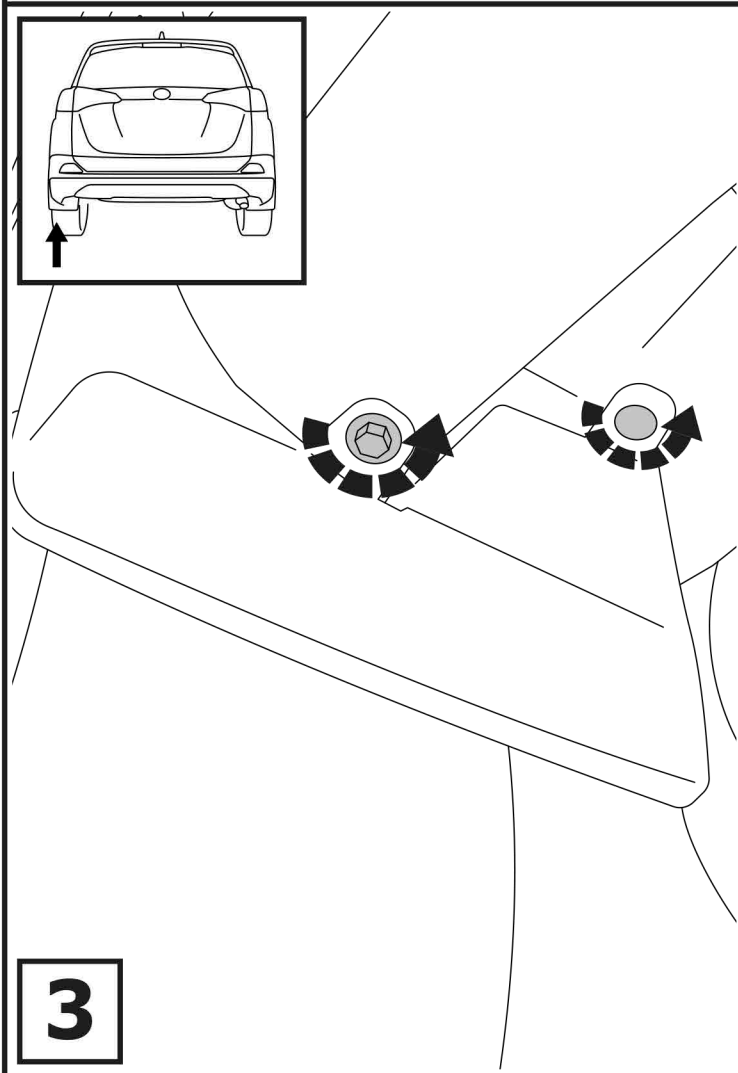
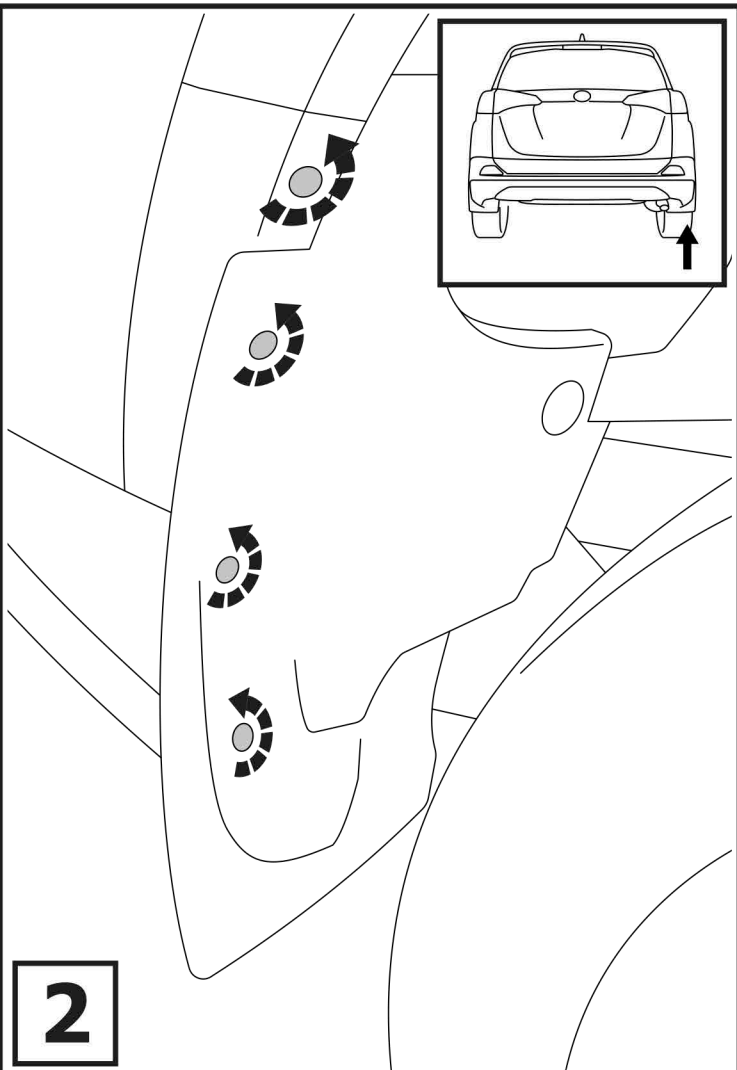
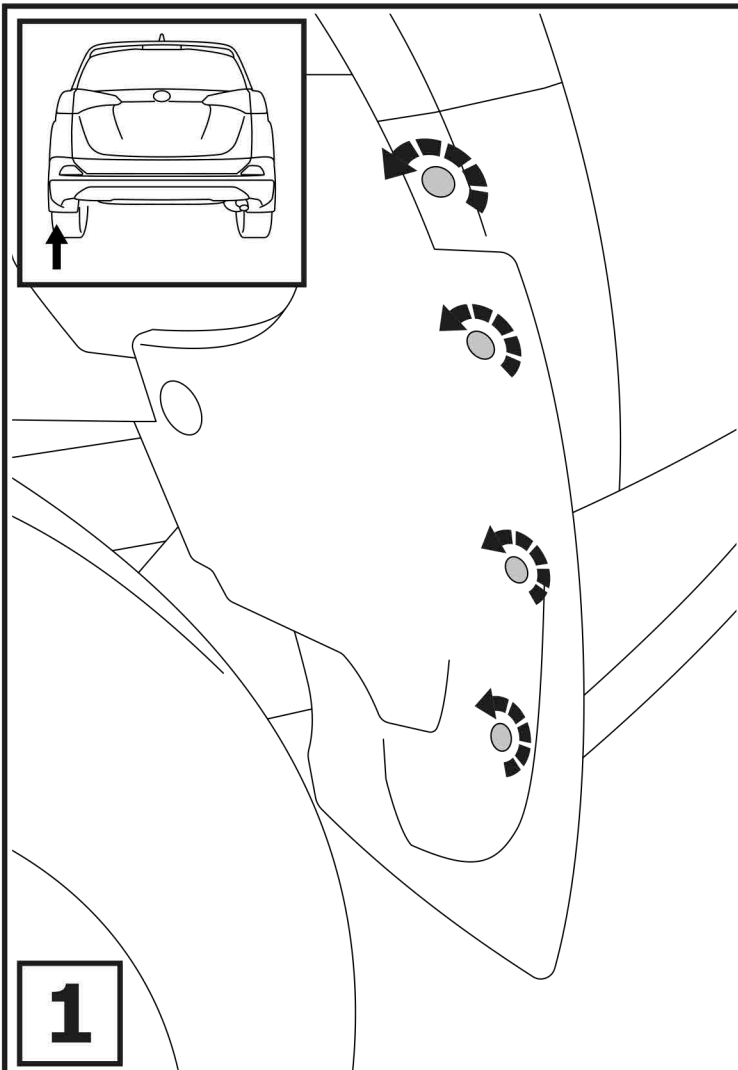

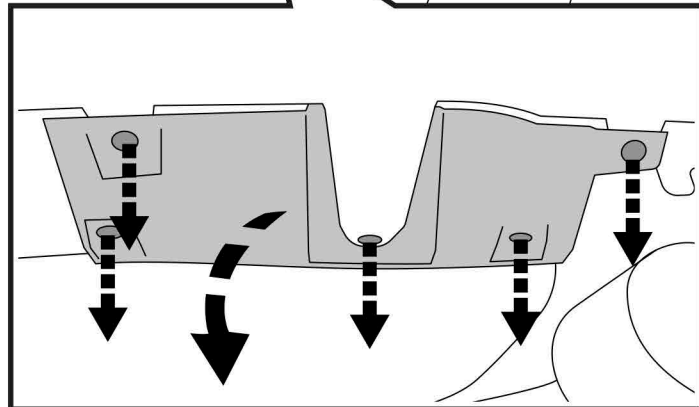
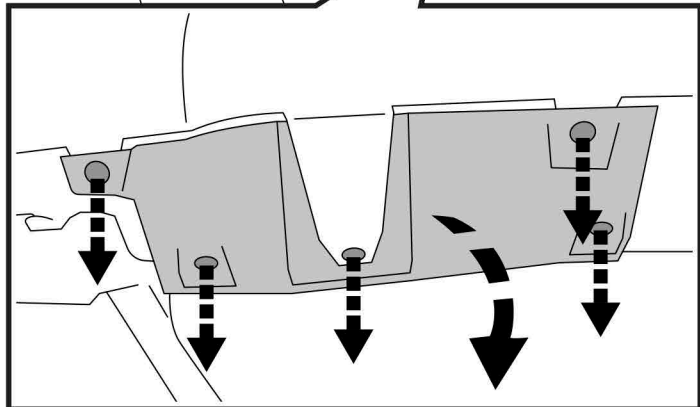
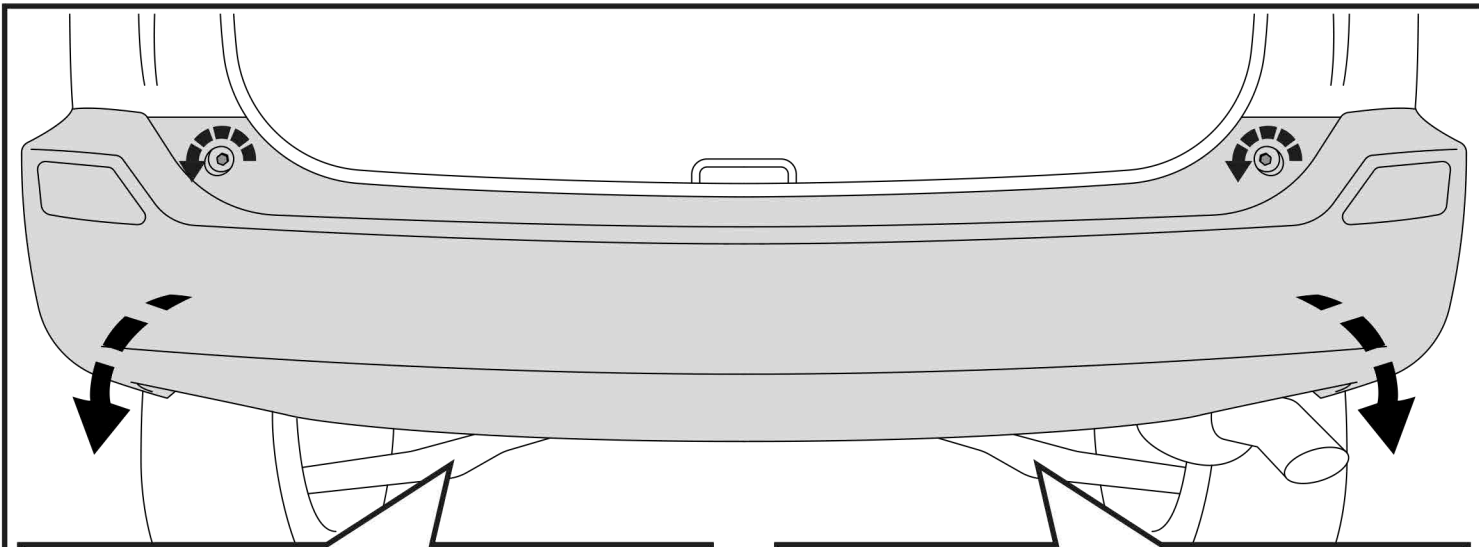

**5**

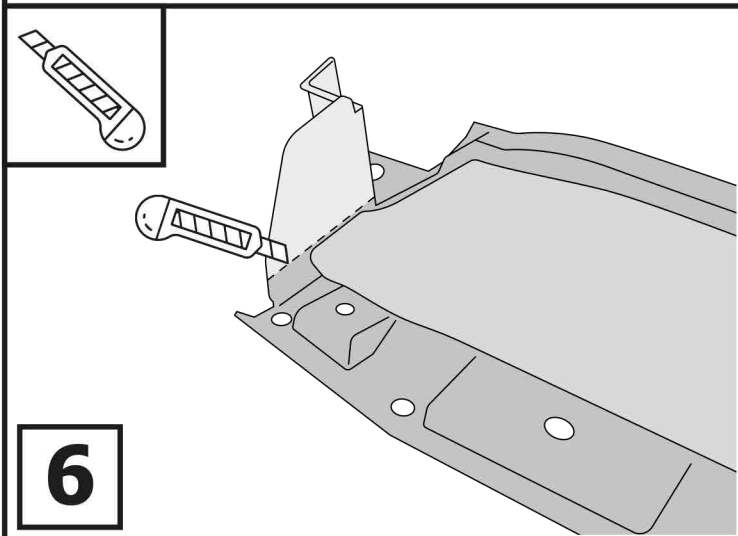

**6**

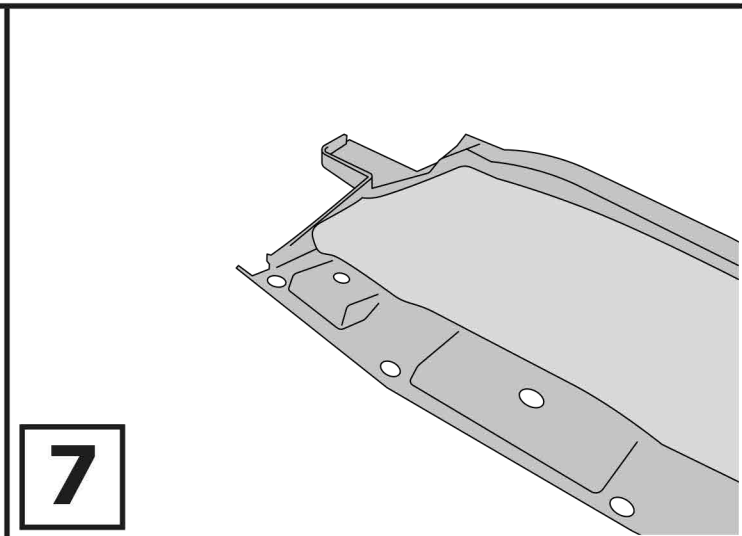

**7**

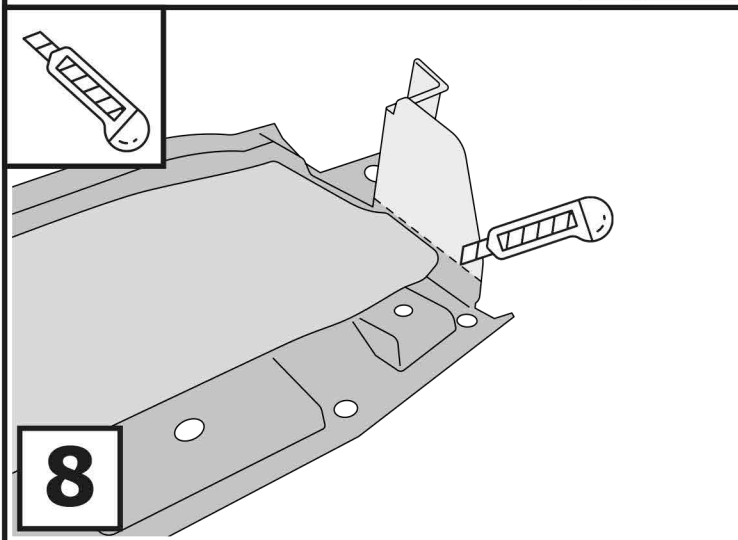

**8**

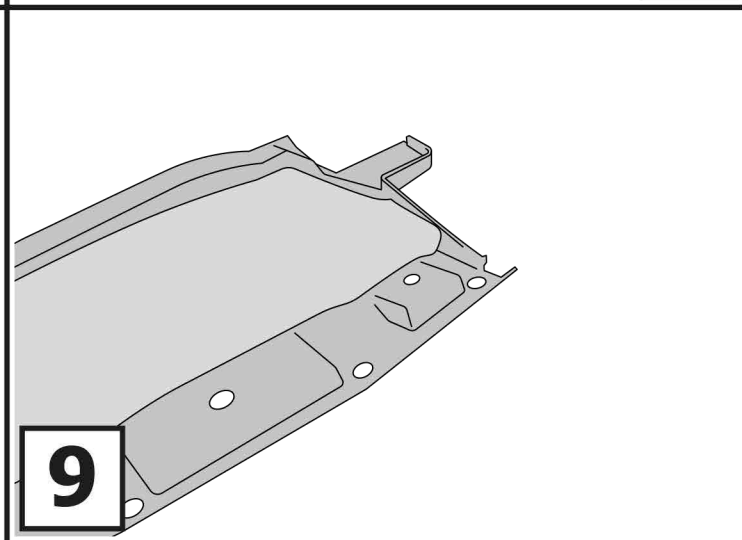

**9**

