

# Инструкция по установке

## LADA Largus

(2012-)



Арт.: F.6017.005

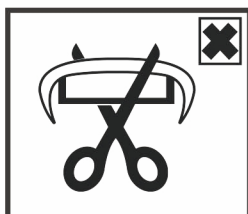
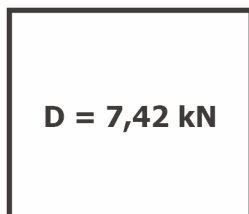
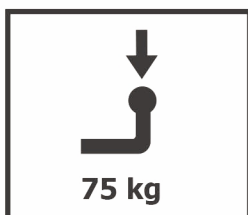
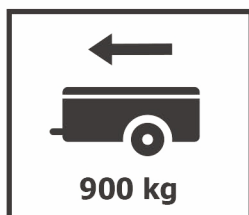

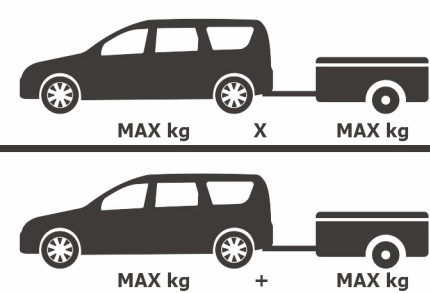
$$D \text{ (kN)} = \frac{\text{MAX kg} \times \text{MAX kg}}{\text{MAX kg} + \text{MAX kg}} \times 0,00981$$

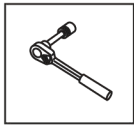

Вкрутить/выкрутить используя инструмент

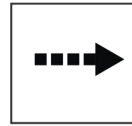

Движение

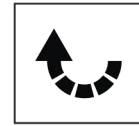

Поворот



Вкрутить/выкрутить не затягивая

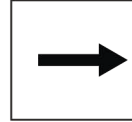





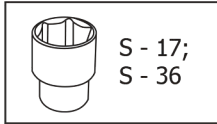
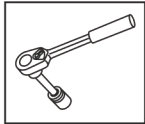



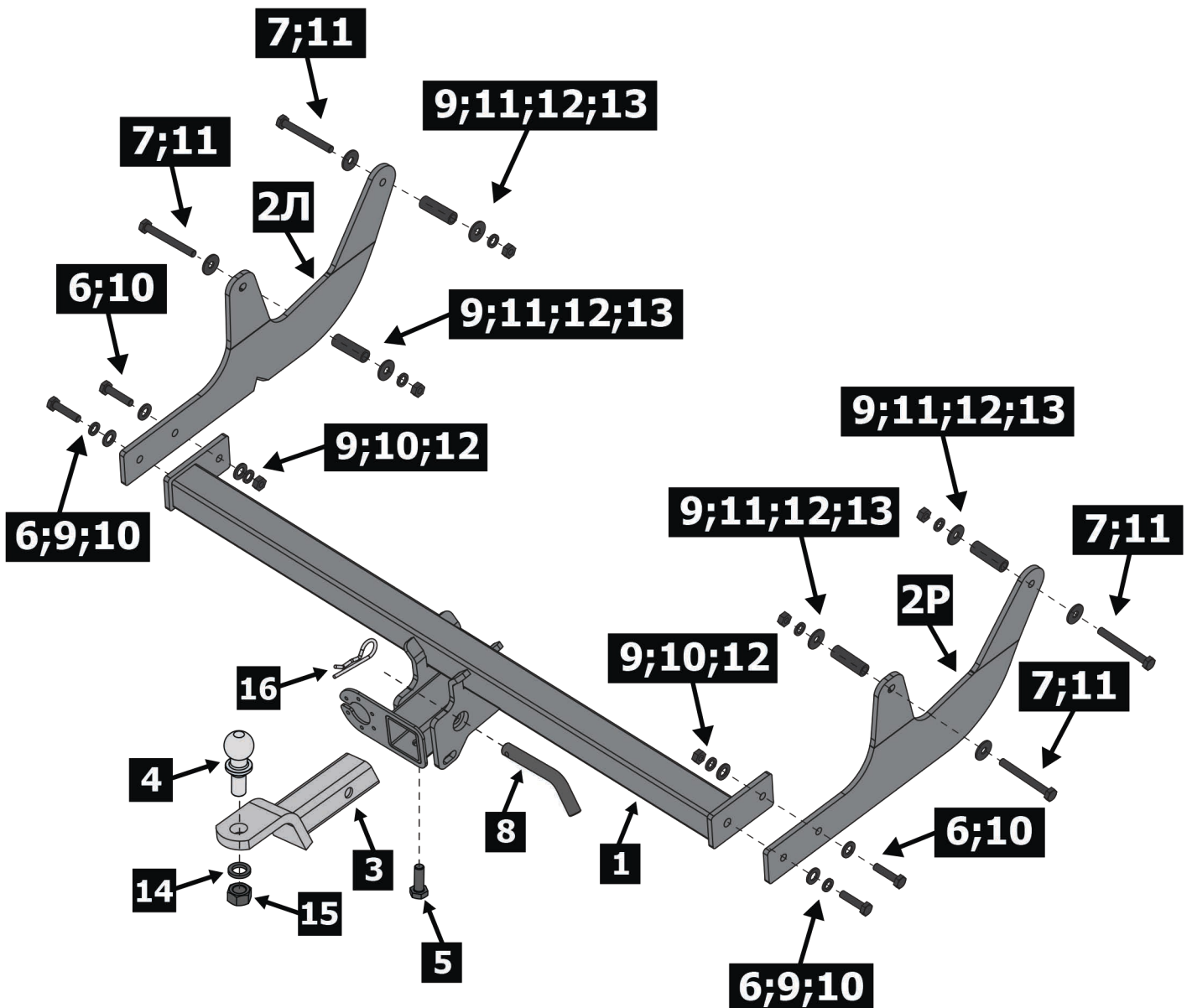

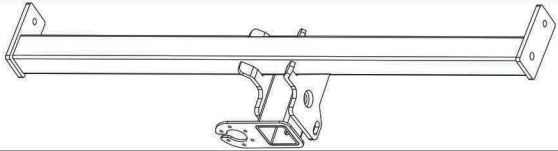
Расположение

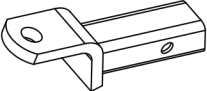
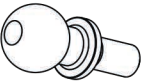
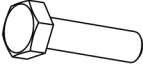
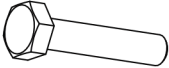
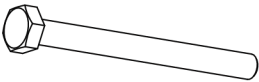
### Используемый инструмент:



S - 17;  
S - 36

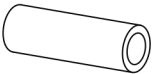

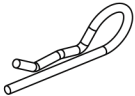
<b>1</b>	x1	Балка	
<b>2Л</b>	x1	Кронштейн левый	
<b>2Р</b>	x1	Кронштейн правый	
<b>3</b>	x1	Переходник	
<b>4</b>	x1	Шар	
<b>5</b>	x1	M10x20	
<b>6</b>	x4	M10x35	
<b>7</b>	x4	M10x90	
<b>8</b>	x1	Штифт	
<b>9</b>	x8	∅ 10	
<b>10</b>	x6	∅ 10	
<b>11</b>	x8	∅ 10	
<b>12</b>	x6	M10	
<b>13</b>	x4	Втулка	
<b>14</b>	x1	∅24	
<b>15</b>	x1	M24	
<b>16</b>	x1	Шплинт	

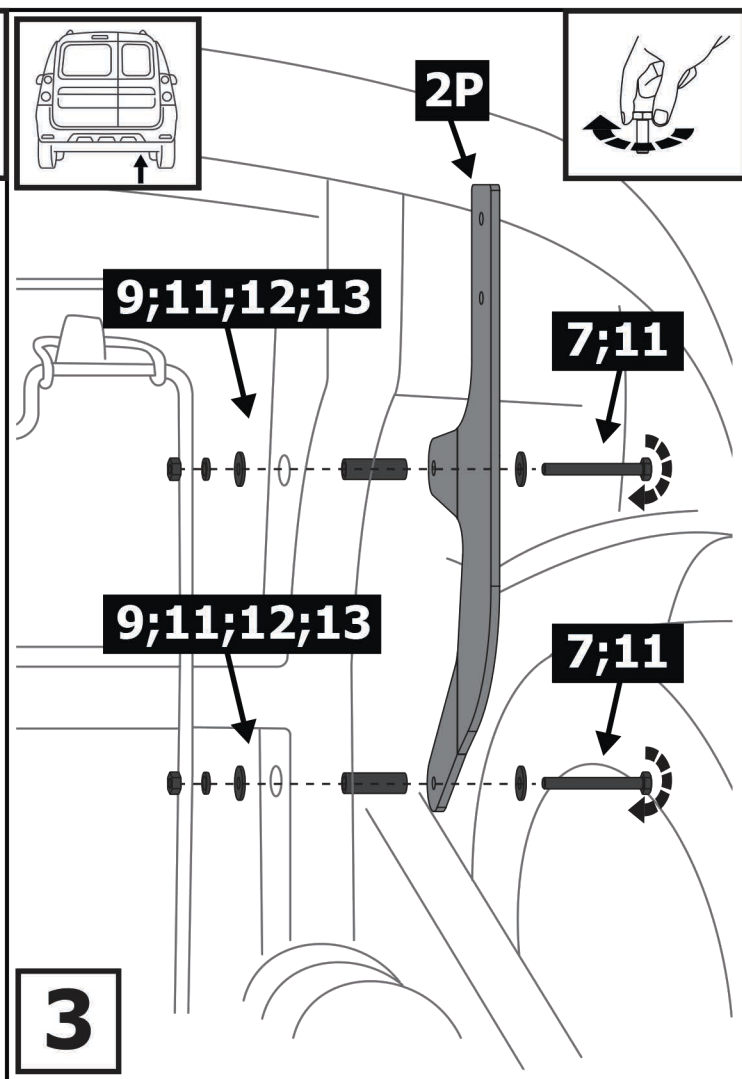
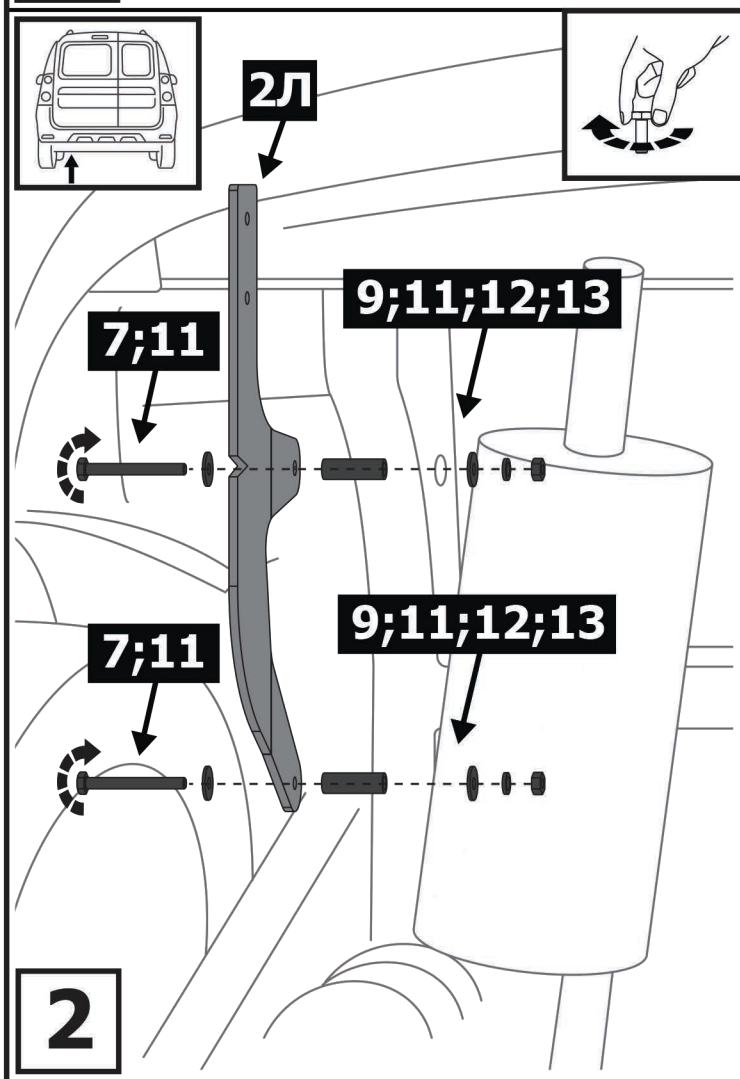
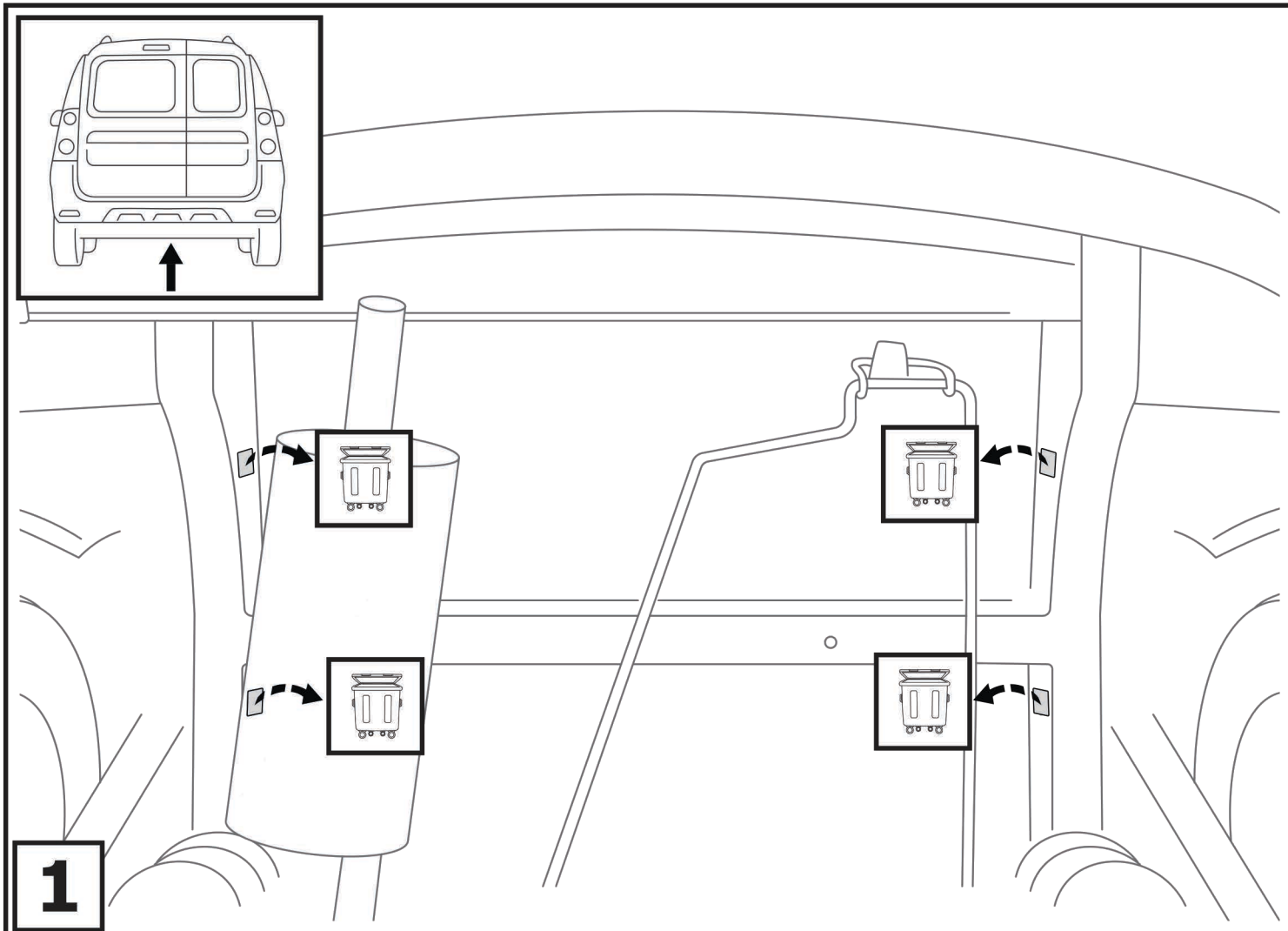

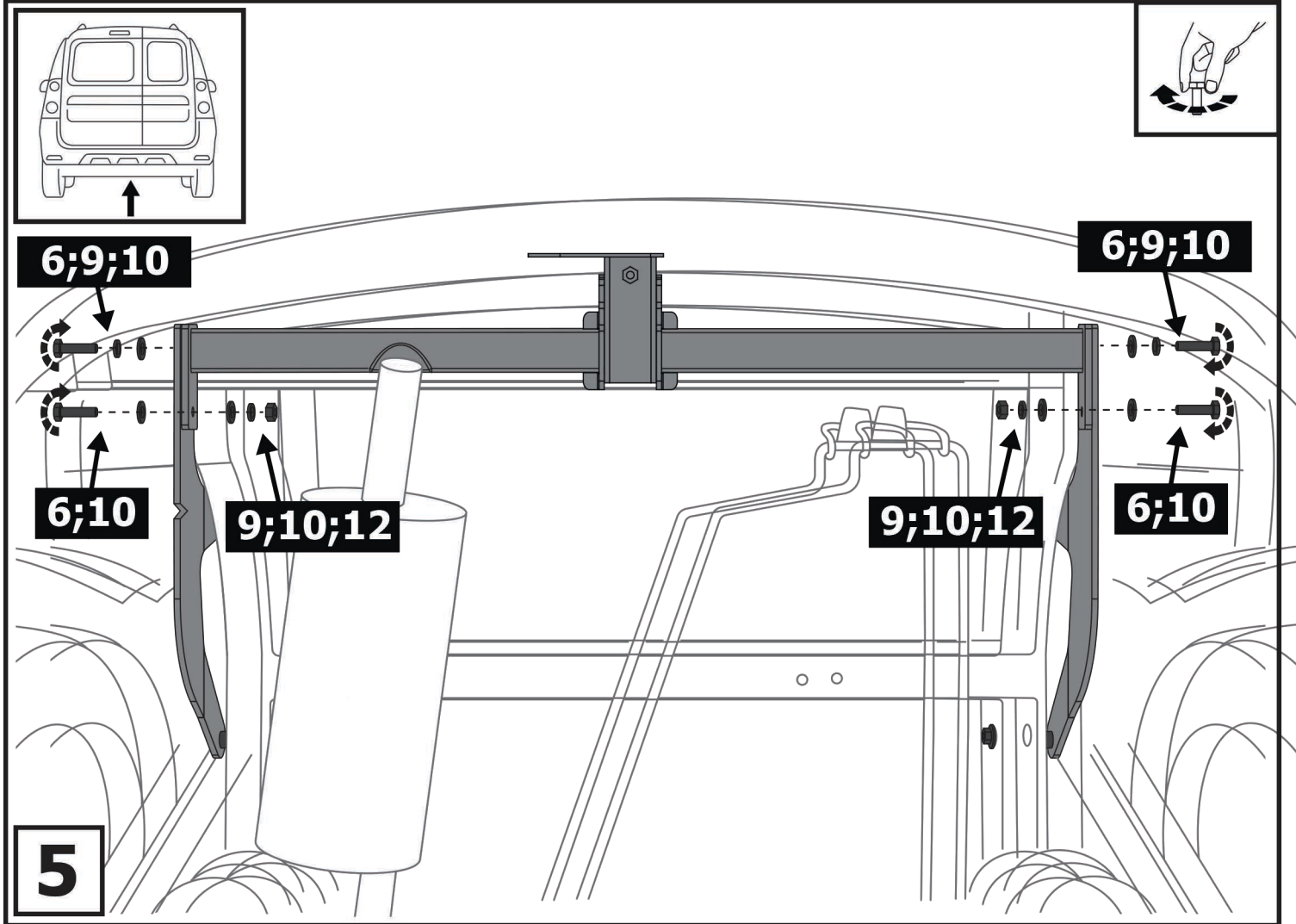
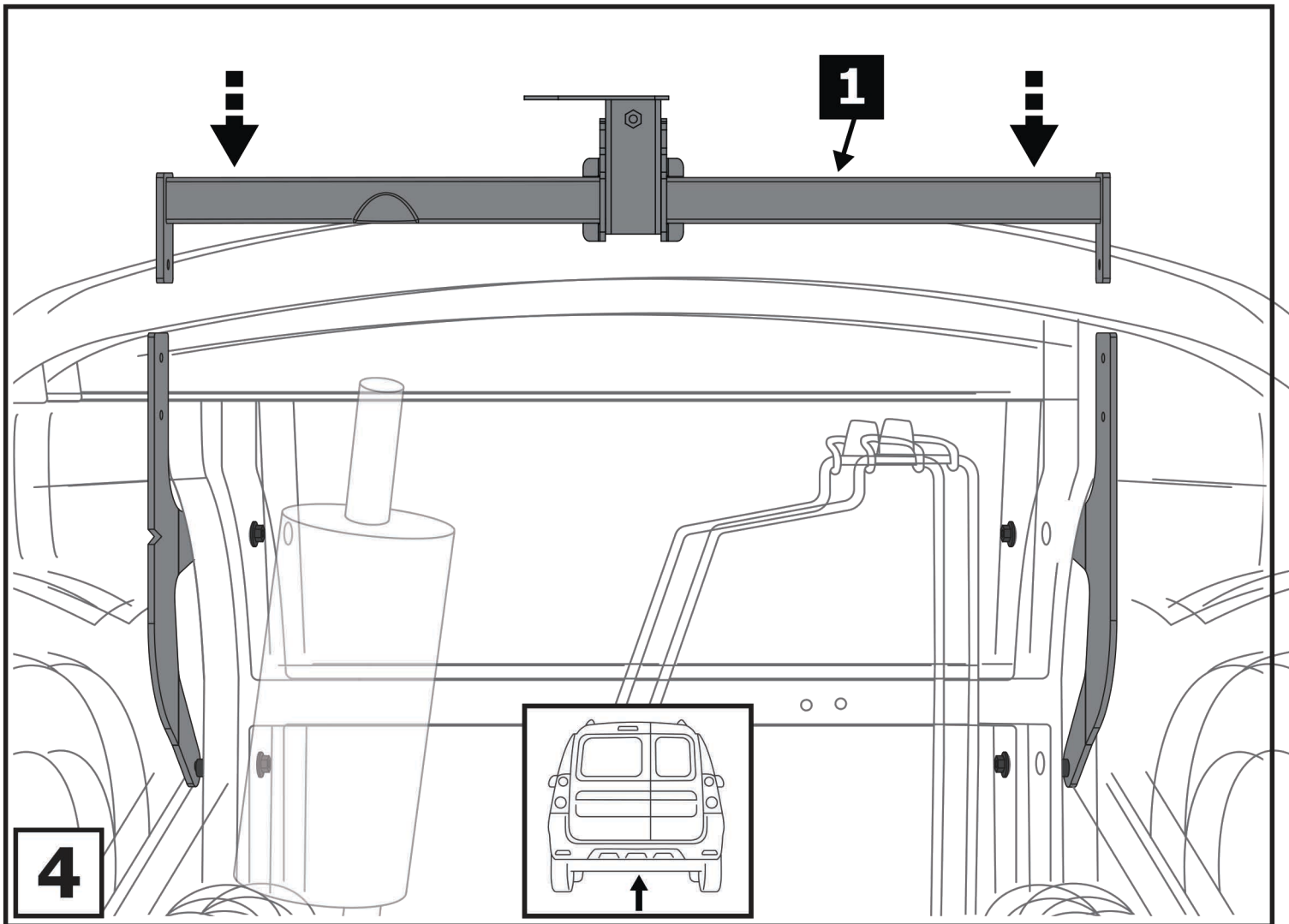

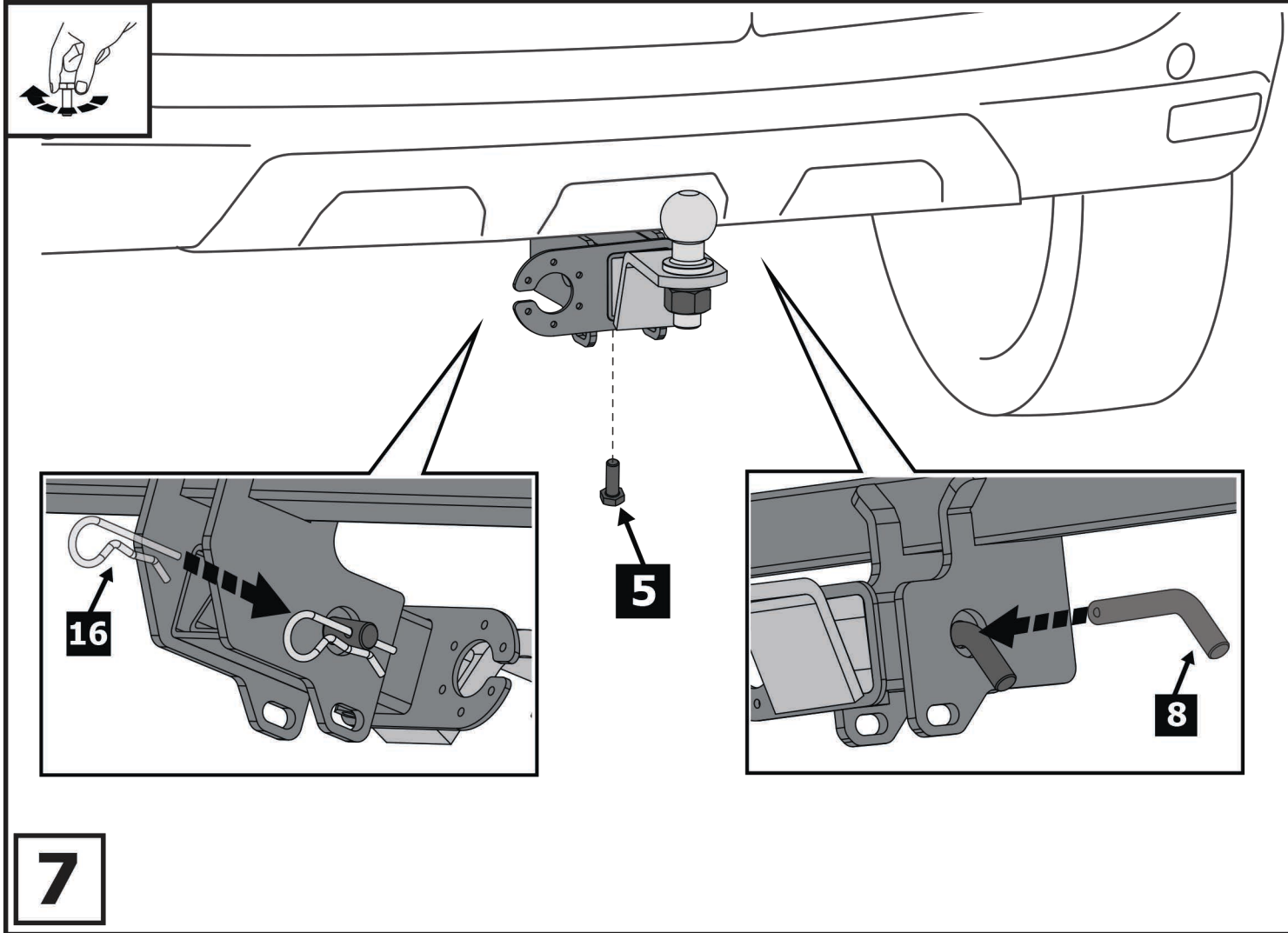
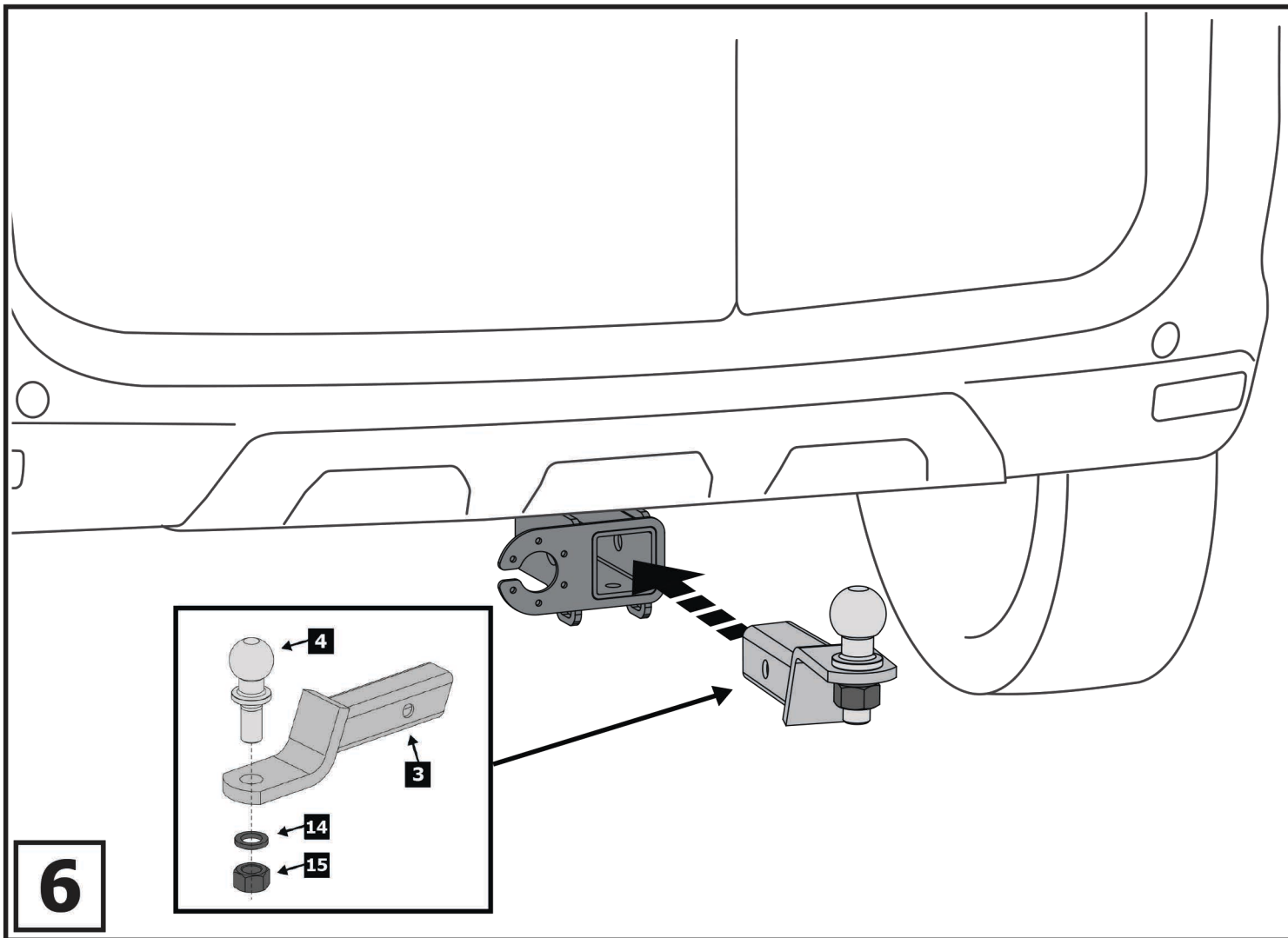

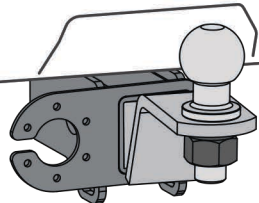

**8**

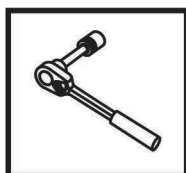

**Затянуть все резьбовые соединения**

**M10 = 47 Nm    M24 = 730 Nm**